

# ICOM

## INSTRUCTION MANUAL

144 MHz FM TRANSCEIVER

**IC-281H**

**IC-281A**

**IC-281E**

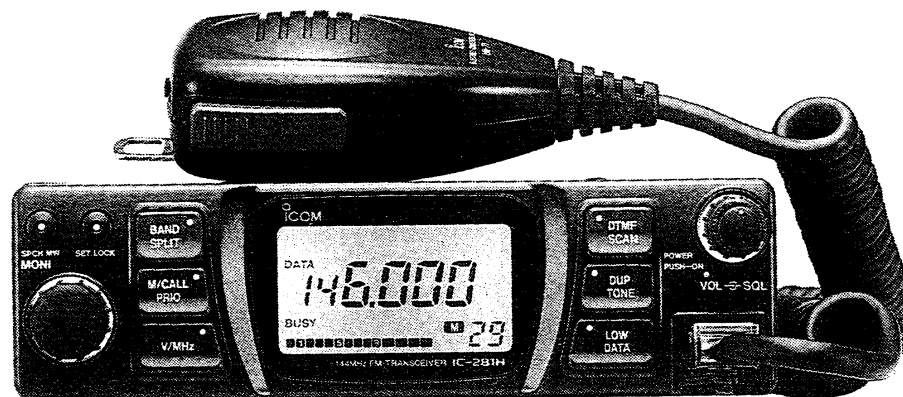

Icom Inc.

---

## IMPORTANT

---

**READ ALL INSTRUCTIONS** carefully and completely before using the transceiver.

**SAVE THIS INSTRUCTION MANUAL** – This instruction manual contains important safety and operating instructions for the IC-281H/A/E.

---

## FOREWORD

---

The IC-281H/A/E is a compact, easy-to-operate, multi-function transceiver designed using Icom's state-of-the-art technology. It is operational on the 144 MHz band and has a 430(440) MHz receiving capability.

**NOTE:** See "Unpacking" on p. 55 for included accessories.

---

## CAUTIONS

---

**NEVER** connect the transceiver to an AC outlet or to a power source of more than 16 V DC. These connections will ruin the transceiver.

**NEVER** connect the transceiver to a power source using reverse polarity. This connection will ruin the transceiver.

**NEVER** place the transceiver where normal operation of the vehicle may be hindered or where it could cause bodily injury.

**NEVER** allow children to touch the transceiver.

**DO NOT** use or place the transceiver in areas with temperatures below  $-10^{\circ}\text{C}$  ( $+14^{\circ}\text{F}$ ) or over  $+60^{\circ}\text{C}$  ( $+140^{\circ}\text{F}$ ) or, in areas subject to direct sunlight, such as the dashboard.

**AVOID** the use of chemical agents such as benzene or alcohol when cleaning, as they can damage the transceiver surfaces.

**BE CAREFUL!** The transceiver will become hot when operating the transceiver continuously for long periods.

# TABLE OF CONTENTS

IMPORTANT .....	i	■ Auto repeater function .....	20	<b>13 POCKET BEEP AND TONE SQUELCH</b> .....	<b>39</b>
FOREWORD .....	i	■ Tone scan .....	20	■ Pocket beep operation .....	39
CAUTIONS .....	i	<b>7 MEMORY OPERATION</b> .....	<b>21–24</b>	■ Tone squelch operation .....	39
TABLE OF CONTENTS .....	ii	■ General description .....	21	<b>14 UP SWITCH REMOTE</b> .....	<b>40</b>
<b>1 PANEL DESCRIPTION</b> .....	<b>1–7</b>	■ Memory channel selection .....	21	■ Assigning a function to the [UP] switch .....	40
■ Front panel .....	1	■ Programming a memory channel .....	22	<b>15 MIC DTMF REMOTE</b> .....	<b>41–42</b>
■ Function display .....	3	■ Transferring memory contents .....	23	<b>16 DTMF MEMORY OPERATION</b> .....	<b>43–46</b>
■ Rear panel .....	5	■ Memory area setting .....	23	■ General .....	43
■ Microphone .....	5	■ Memory channel allocation .....	24	■ Mode types .....	43
■ Packet connection .....	7	■ Auto channel advance .....	24	■ Writing a DTMF memory .....	43
<b>2 INSTALLATION</b> .....	<b>8–10</b>	<b>8 CALL CHANNEL OPERATION</b> .....	<b>25</b>	■ Transmitting memory data .....	44
■ Location .....	8	■ Calling up a call channel .....	25	■ Clearing memory data .....	44
■ Mounting .....	8	■ Transferring a call channel's contents .....	25	■ Re-dial function .....	45
■ Battery connection .....	9	■ Programming a call channel .....	25	■ 1750 Hz tone call .....	46
■ DC power supply connection .....	9	<b>9 SCRATCH PAD MEMORY</b> .....	<b>26</b>	<b>17 OTHER FUNCTIONS</b> .....	<b>47–50</b>
■ Antenna installation .....	10	■ What is a scratch pad memory .....	26	■ Display dimmer setting .....	47
<b>3 MODE ARRANGEMENT CHART</b> .....	<b>11–12</b>	■ Calling up a scratch pad memory .....	26	■ Beep tone on/off .....	47
<b>4 SETTING A FREQUENCY</b> .....	<b>13–14</b>	<b>10 SCAN OPERATION</b> .....	<b>27–32</b>	■ Time-out timer .....	48
■ Using the tuning dial .....	13	■ Scan types .....	27	■ Auto power-off .....	48
■ Tuning step selection .....	13	■ Full scan and programmed scan .....	28	■ Optional voice synthesizer .....	49
■ Using [UP]/[DN] switches .....	14	■ Programming scan edges .....	29	■ Demonstration display .....	49
■ Lock function .....	14	■ Scan edge selection .....	30	■ Optional unit installation .....	50
<b>5 BASIC OPERATION</b> .....	<b>15–17</b>	■ Memory scan .....	30	<b>18 MAINTENANCE</b> .....	<b>51–53</b>
■ Receiving .....	15	■ Skip channel setting .....	31	■ Troubleshooting .....	51
■ Monitor function .....	15	■ Scan resume condition .....	32	■ Fuse replacement .....	52
■ Receive band .....	16	<b>11 PRIORITY WATCH</b> .....	<b>33–34</b>	■ Backup batteries .....	52
■ Transmitting .....	16	■ Priority watch types .....	33	■ Partial resetting .....	53
■ Selecting the output power .....	17	■ Priority watch operation .....	34	■ Resetting the transceiver .....	53
■ Crossband full duplex .....	17	<b>12 PAGER AND CODE SQUELCH</b> .....	<b>35–38</b>	<b>19 SPECIFICATIONS</b> .....	<b>54</b>
<b>6 REPEATER OPERATION</b> .....	<b>18–20</b>	■ General description .....	35	<b>20 OPTIONS</b> .....	<b>55–56</b>
■ Operation .....	18	■ Code programming .....	36	■ Unpacking .....	55
■ Tone information .....	18	■ Pager operation .....	37	■ Options .....	55
■ Subaudible tone .....	19	■ Code squelch operation .....	38		
■ Offset frequency .....	19				

# 1

## PANEL DESCRIPTION

### Front panel

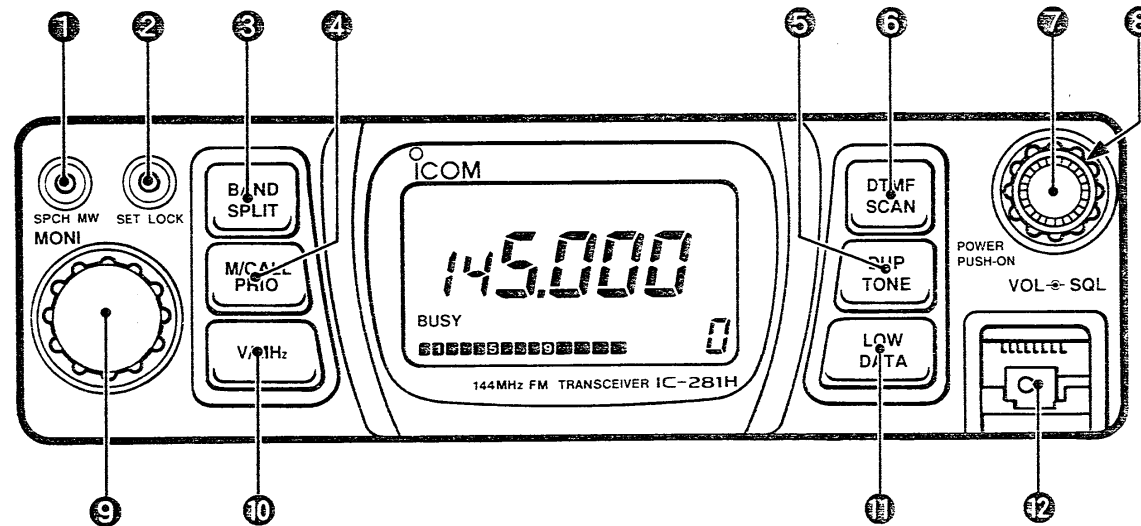

#### ① SPEECH/MEMORY WRITE SWITCH [SPCH·MW]

- Programs a memory channel or a call channel when pushed and held. (pgs. 22, 25) Also advances the memory channel number when continuously pushing after programming is completed. (p. 24)
- Transfers the contents of a memory channel, call channel or scratch pad memory to a VFO. (pgs. 23, 25, 26)
- Announces the displayed frequency in a synthesized voice when an optional UT-66 VOICE SYNTHESIZER UNIT is installed. (p. 49)
- Reverses the set mode selection order in set mode. (p. 12)

#### ② SET MODE SWITCH [SET·LOCK]

- Accesses set mode and advances the set mode display. (p. 12)
- Activates the lock function when pushed and held. (p. 14)
- Accesses code channel display and advances it when pager or code squelch is activated. (p. 36)

#### ③ BAND/SPLIT SWITCH [BAND·SPLIT]

- Selects the main band or receive band. (p. 16)
- Selects crossband full duplex function when pushed and held (when receive band is selected). (p. 17)

- ④ **MEMORY/CALL CHANNEL SWITCH [M/CALL•PRIO]**
  - Selects memory mode or a call channel. (pgs. 21, 25)
  - Activates the priority watch function when pushed and held. (p. 34)
  - Cancels the priority watch function when priority watch is activated. (p. 34)
- ⑤ **DUPLEX/TONE SWITCH [DUP•TONE]**
  - Selects simplex, – duplex or + duplex. (p. 18)
  - Activates the subaudible tone encoder\* (p. 18); pocket beep (p. 39) or tone squelch function (p. 39) when pushed and held (main band only).

\* U.S.A. and Korea versions : Built-in  
 Other versions : Optional except for 88.5 Hz.
- ⑥ **DTMF/SCAN SWITCH [DTMF•SCAN]**
  - Activates the pager, code squelch or Mic DTMF remote functions. (pgs. 37, 38, 41)
  - Starts scan in VFO or memory mode when pushed and held. (pgs. 28, 30)
  - Starts tone scan when pushed and held while the optional tone squelch is in use. (p. 20)
- ⑦ **VOLUME CONTROL/POWER SWITCH [VOL•POWER]**
  - Turns power ON and OFF when pushed for 1 sec. (p. 15)
  - Adjusts the volume. (p. 15)

- ⑧ **SQUELCH CONTROL [SQL]** (p. 15)
  - Varies the squelch threshold point for noise mute.
- ⑨ **TUNING DIAL/MONITOR SWITCH [MONI]**
  - Selects the operating frequency (p. 13), the memory channel (p. 21), the contents of the set mode display (p. 12) and the scanning direction (pgs. 28, 30).
  - Opens the squelch while pushed and held. (p. 15)
- ⑩ **V/MHz SWITCH [V/MHz]**
  - Selects VFO mode. (p. 13)
  - Selects the 1 MHz tuning step in VFO mode. (p. 13)
  - Selects the 10 MHz tuning step when pushed and held. Some versions do not have the 10 MHz tuning step.
- ⑪ **TRANSMIT POWER/DATA SWITCH [LOW•DATA]**
  - Selects the transmit output power levels for the main band. (p. 17)
  - Selects data mode for 9600 bps packet operation when pushed and held. (p. 7)
- ⑫ **MICROPHONE CONNECTOR** (p. 5)
  - Connects the supplied microphone or another suitable microphone.

# 1 PANEL DESCRIPTION

## ■ Function display

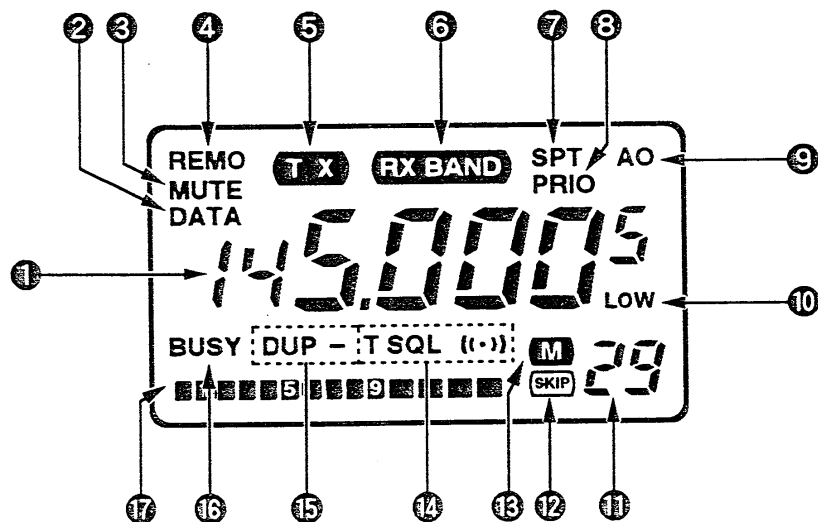

### 1 FREQUENCY READOUT

Shows the operating frequency, set mode contents, etc.

- The decimal point of the frequency flashes while scanning. (pgs. 28, 30)
- "P" or "C" appears in place of the 100 MHz digit while the pager or code squelch function is in use, respectively. (pgs. 37, 38)

### 2 DATA INDICATOR (p. 7)

Appears when data mode is selected for 9600 bps packet operation.

### 3 AUDIO MUTE INDICATOR (p. 42)

Appears while the audio mute function\* is activated.

\* The HM-77/A is required to activate the function.

### 4 REMOTE INDICATOR (p. 41)

Appears while Mic DTMF Remote\* is in standby. Flashes while the function is activated.

\* The HM-77/A is required to use the function.

### 5 TRANSMIT INDICATOR (p. 16)

Appears while transmitting.

### 6 RECEIVE BAND INDICATOR (p. 16)

Appears when the receive band is selected.

### 7 SPLIT INDICATOR (p. 17)

Appears while the crossband full duplex function is activated.

### 8 PRIORITY WATCH INDICATOR (p. 34)

Appears while a priority watch is activated; flashes while the watch is paused.

### 9 AUTO POWER-OFF INDICATOR (p. 48)

Appears while the auto power-off function is in use.

### 10 LOW POWER INDICATOR (p. 17)

Appears while low output power 1 or 2 is selected.

**⑪ MEMORY CHANNEL READOUT**

Shows the selected memory channel numbers. (p. 21)

- "L" appears while the lock function is in use. (p. 14)
- A large "C" appears while on a call channel. (p. 25)
- "r1"–"r5" appear when a duplex scratch pad memory is selected. (p. 26)
- "L1"–"L5" appear when a simplex scratch pad memory is selected. (p. 26)
- A small "c" appears when VFO mode is selected from the call channel or a scratch pad memory. (p. 25, 26)

**⑫ SKIP INDICATOR** (p. 31)

Appears when the displayed memory channel is specified as a skip channel.

**⑬ MEMORY INDICATOR** (p. 21)

Appears when memory mode is selected.

**⑭ TONE INDICATOR**

- "T" appears while the subaudible tone encoder\* is in use. (p. 18)
- "T SQL" appears while the optional tone squelch function is in use. (p. 39)
- "T SQL (i•)" appears while the optional pocket beep function is in use. (p. 39)

\* U.S.A. and Korea versions : Built-in

Other versions : Optional except for 88.5 Hz.

**⑮ DUPLEX INDICATOR** (p. 18)

"DUP –" or "DUP" appears during semi-duplex operation (repeater operation).

**⑯ BUSY INDICATOR** (p. 15)

Appears when a signal is received or the squelch is open.

**⑰ S/RF INDICATOR**

- Shows the relative strength while receiving signals. (p. 15)
- Shows the output power selection while transmitting. (p. 17)

# 1 PANEL DESCRIPTION

## ■ Rear panel

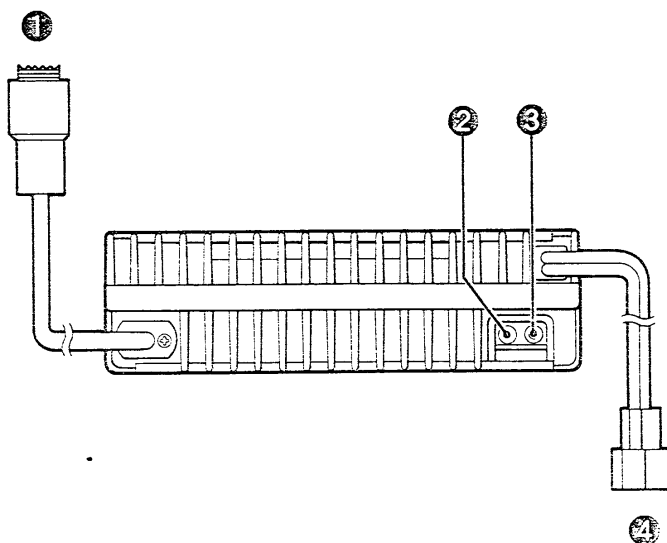

- ① **ANTENNA CONNECTOR [ANT 144MHz]** (p. 10)  
Accepts a 50  $\Omega$  antenna with a PL-259 connector.
- ② **EXTERNAL SPEAKER JACK [SP]**  
Connects a 4–8  $\Omega$  speaker, if required.
- ③ **DATA JACK [DATA]**  
Connects a 2.5 mm stereo plug for data communication.  
See p. 7 for details.
- ④ **POWER RECEPTACLE [DC13.8V]** (p. 9)  
Accepts 13.8 V DC with the supplied DC power cable.

## ■ Microphone

- HM-77/A, HM-78 and HM-79

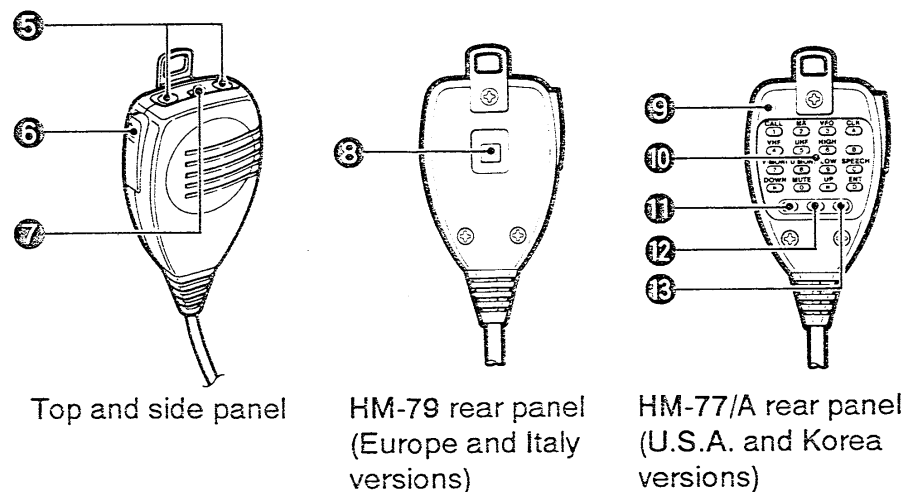

- ⑤ **FREQUENCY UP/DOWN SWITCHES [UP], [DN]**
  - Push either switch to change the operating frequency or memory channel.
  - Push and hold either switch to start scanning.
  - Once a function has been programmed for Up Switch Remote, [UP] activates the programmed function and [DN] starts scanning. (p. 40)
  - [UP] activates Mic DTMF Remote when in standby. The HM-77/A is required for setting a frequency, etc. (p. 41)
- ⑥ **PTT SWITCH**  
Push and hold to transmit; release to receive.



⑦ **LOCK SWITCH [LOCK]**

Prevents accidental input from all keys except the PTT switch and [TONE] of the HM-79 HAND MICROPHONE.

⑧ **TONE CALL SWITCH [TONE]** (HM-79 only)

Push and hold to transmit a 1750 Hz tone call signal for repeater access. (p. 18)

⑨ **ACTIVE INDICATOR** (HM-77/A only)

Lights up or flashes when a key is pushed or a tone is being transmitted. (p. 43)

⑩ **DTMF KEYBOARD** (HM-77/A only)

Use DTMF codes for auto patching, repeater control, Mic DTMF Remote and other functions.

- Attach the supplied microphone sheet to the HM-77/A keyboard.

⑪ **MEMORY WRITE KEY [MW]** (HM-77/A only)

Used when writing a DTMF code into DTMF memory or re-dial code memory. (p. 43)

⑫ **MEMORY READ KEY [MR]** (HM-77/A only)

Used when recalling and transmitting a DTMF code from DTMF code memory. (p. 44)

⑬ **RE-DIAL KEY [RD]** (HM-77/A only)

Used when recalling and transmitting the last-transmitted DTMF code. (p. 45)

◇ **Microphone connector** (front panel view)

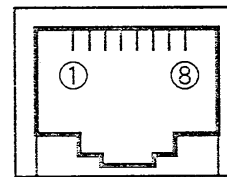

- ① + 8 V DC output
- ② Frequency up/down
- ③ AF detector output (same as the [SP] jack output)
- ④ PTT
- ⑤ GND (Microphone ground)
- ⑥ MIC (Microphone input)
- ⑦ GND
- ⑧ NC (No connection)

# 1 PANEL DESCRIPTION

## ■ Packet connection

### ◇ Data connection

The transceiver has a [DATA] jack and data mode for reliable packet operation. Connect a TNC (Terminal Node Controller) to the [DATA] and [SP] jacks as shown below.

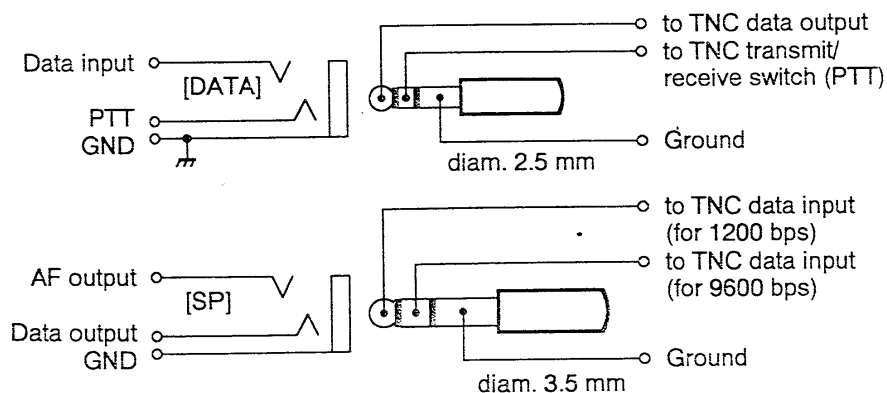

#### NOTE for 9600 bps operation:

Be sure the data input level (TNC output level) is within 0.3–1.2 Vp-p (0.1–0.43 Vrms). We recommend 1.0 Vp-p (0.35 Vrms).

- If the transceiver does not transmit (the transmit indicator flashes or does not illuminate), the input level may be higher.
- If the re-try function is activated frequently, the input level may be lower.

### ◇ Operation

To operate data communication at 9600 bps:

- ① Connect a TNC to the transceiver's [SP] and [DATA] jacks.
- ② Set the operating frequency.
- ③ Push and hold [LOW·DATA] for 1 sec. to select data mode.
  - "DATA" appears.
  - The microphone signals are cut from the modulation circuit while in data mode.
- ④ Control the transceiver from a personal computer, etc.

To operate data communication at 1200 bps:

- ① Connect a TNC to the transceiver's [SP] and [DATA] jacks.
- ② Set the operating frequency.
- ③ Remove the microphone from the transceiver.
- ④ Be sure that data mode is not selected.
  - "DATA" does not illuminate.
- ⑤ Control the transceiver from a personal computer, etc.

#### NOTE for 1200 bps operation:

The data mode can be used for 9600 bps packet operation only. Be sure that data mode is not selected while 1200 bps packet operation.

## ■ Location

Select a location which can support the weight of the transceiver and does not interfere with driving in any way. We recommend the locations shown in the diagram below.

**NEVER** place the transceiver where normal operation of the vehicle may be hindered or where it could cause bodily injury.

**NEVER** place the transceiver where air bag operation may be obstructed.

**DO NOT** place the transceiver where hot or cold air blows directly onto it.

**AVOID** placing the transceiver in direct sunlight.

### ◦ EXAMPLE INSTALLATION LOCATIONS

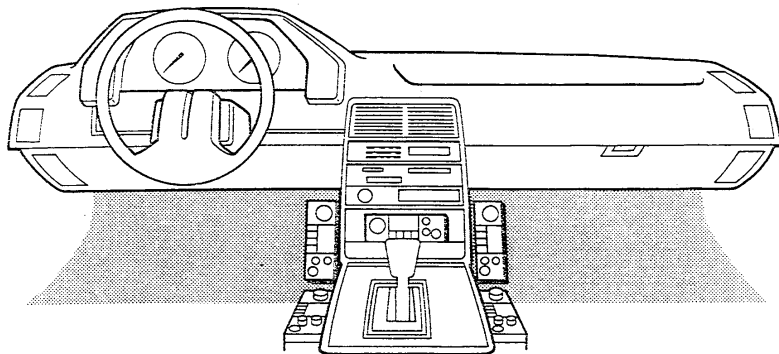

## ■ Mounting

- ① Drill 4 holes where the mounting bracket is to be installed.
  - Approx. 5.5–6 mm when using nuts; approx. 2–3 mm when using self-tapping screws. (1 mm  $\approx$  1/32 in)
- ② Insert the supplied screws, nuts and washers through the mounting bracket and tighten.
- ③ Adjust the angle for the clearest view of the function display.

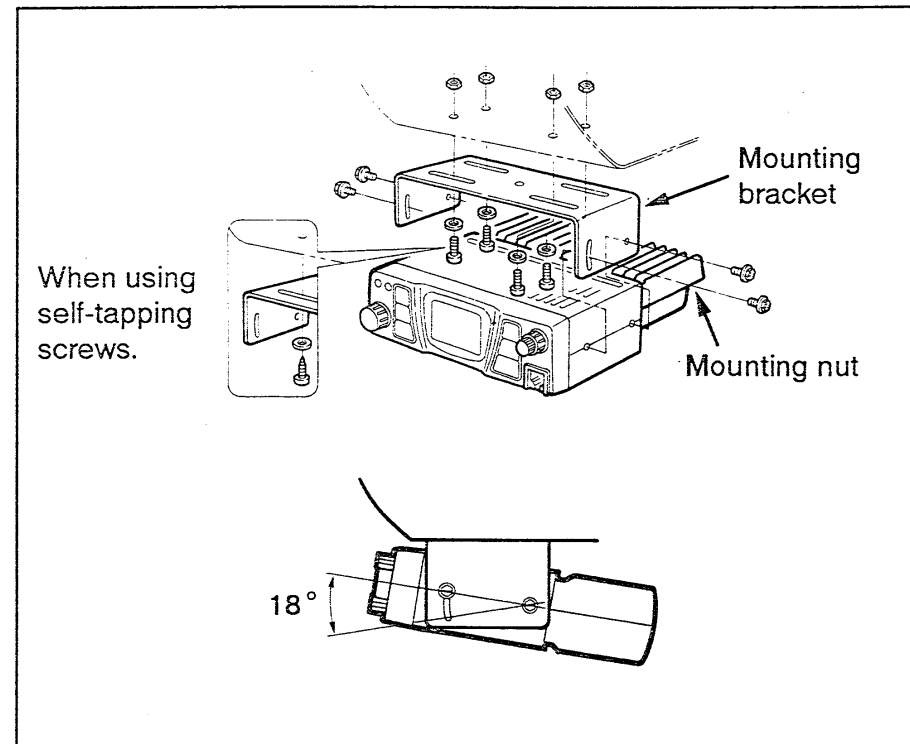

## 2 INSTALLATION

### ■ Battery connection

**NEVER** connect the transceiver directly to a 24 V battery.

**DO NOT** use the cigarette lighter socket for power connections.

Attach a rubber grommet when passing the DC power cable through a metal plate to prevent short circuits.

#### • CONNECTING TO A DC POWER SOURCE

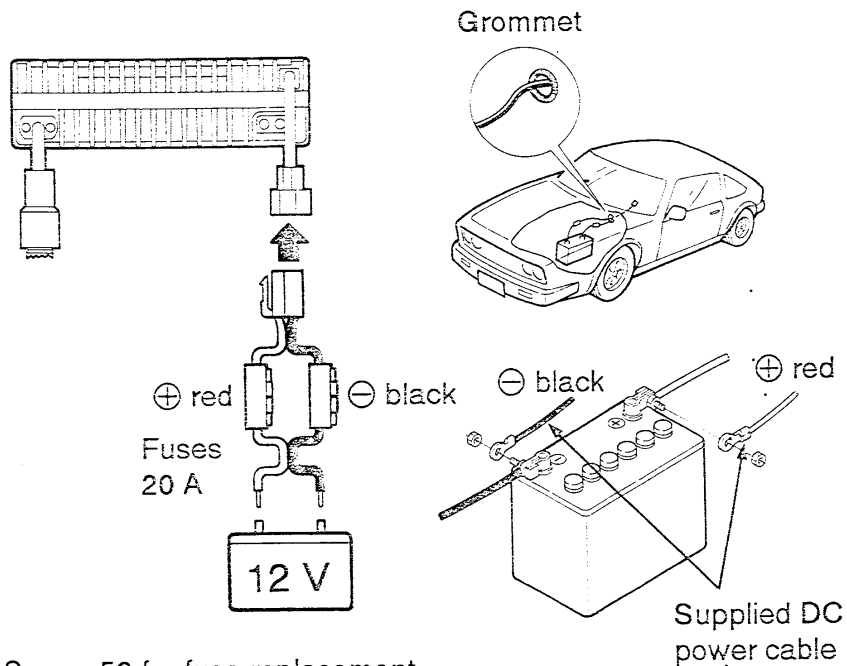

See p. 52 for fuse replacement.

### ■ DC power supply connection

Use a 13.8 V DC power supply with more than 11 A capability. An optional IC-PS30 DC POWER SUPPLY is available for using the transceiver with a DC power supply in your home.

Make sure the ground terminal of the DC power supply is grounded.

#### • CONNECTING TO A DC POWER SUPPLY

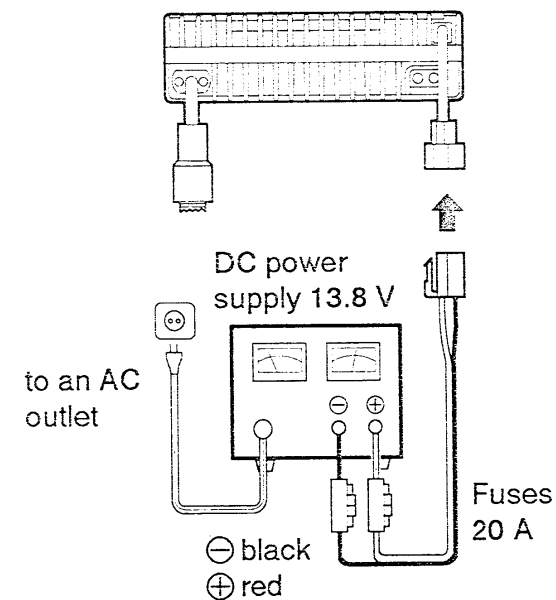

See p. 52 for fuse replacement.

## ■ Antenna installation

### ◇ Antenna location

To obtain maximum performance from the transceiver, select a high-quality antenna and mount it in a good location. A non-radial type antenna should be used when using a magnetic mount.

A 2 m/70 cm dual band antenna is recommended since the transceiver has 430(440) MHz band receiving capability. (p. 16)

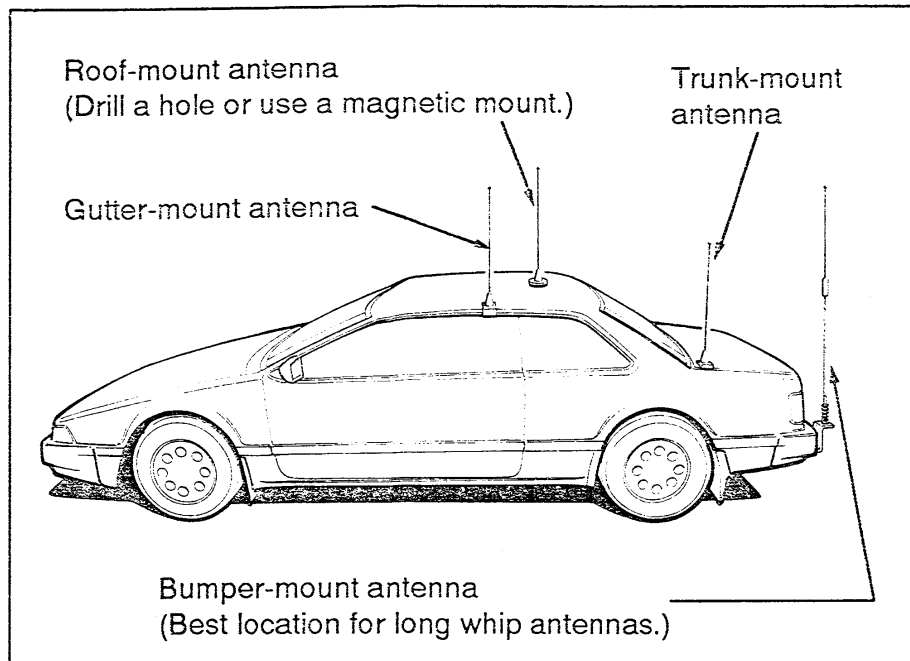

### ◇ Antenna connector

The antenna connector uses a PL-259 connector.

#### • PL-259 CONNECTOR

- ① Slide the coupling ring over the coaxial cable.

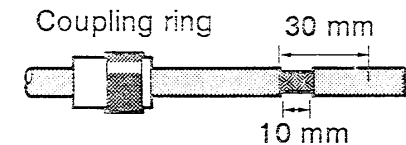

- ② Strip the cable as shown in the diagram, and soft solder the center conductor.

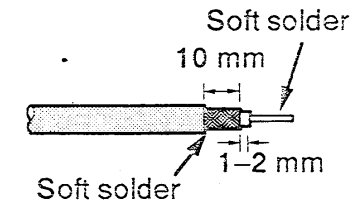

- ③ Slide the connector body onto the cable and solder.

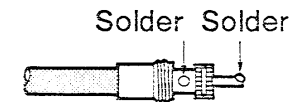

- ④ Screw the coupling ring onto the connector body.

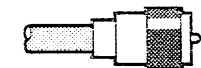

30 mm  $\approx$  9/8 in  
10 mm  $\approx$  3/8 in  
1-2 mm  $\approx$  1/16 in

# 3

## MODE ARRANGEMENT CHART

Although the following chart refers only to the main band, the receive band has the same mode arrangement.

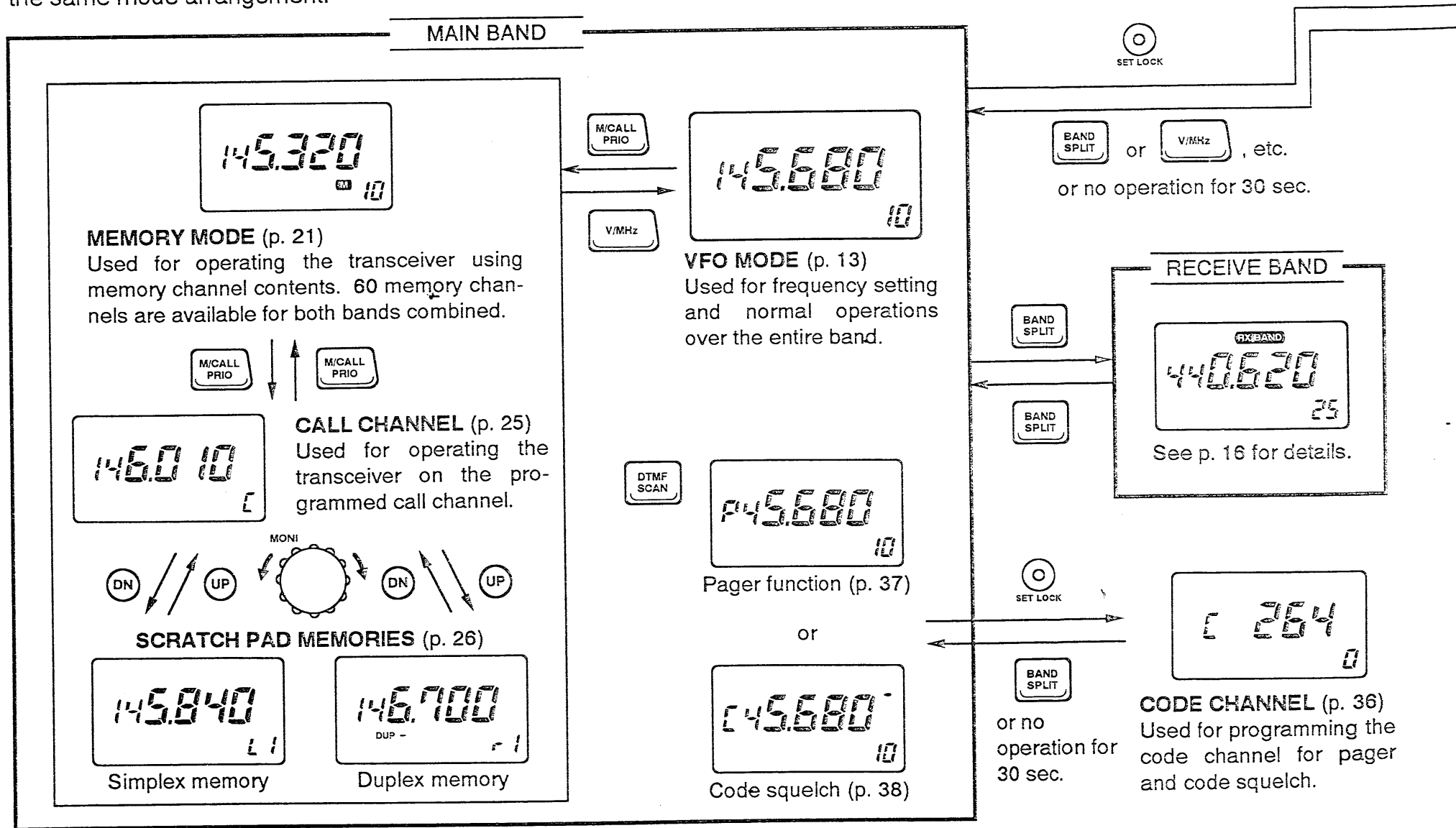

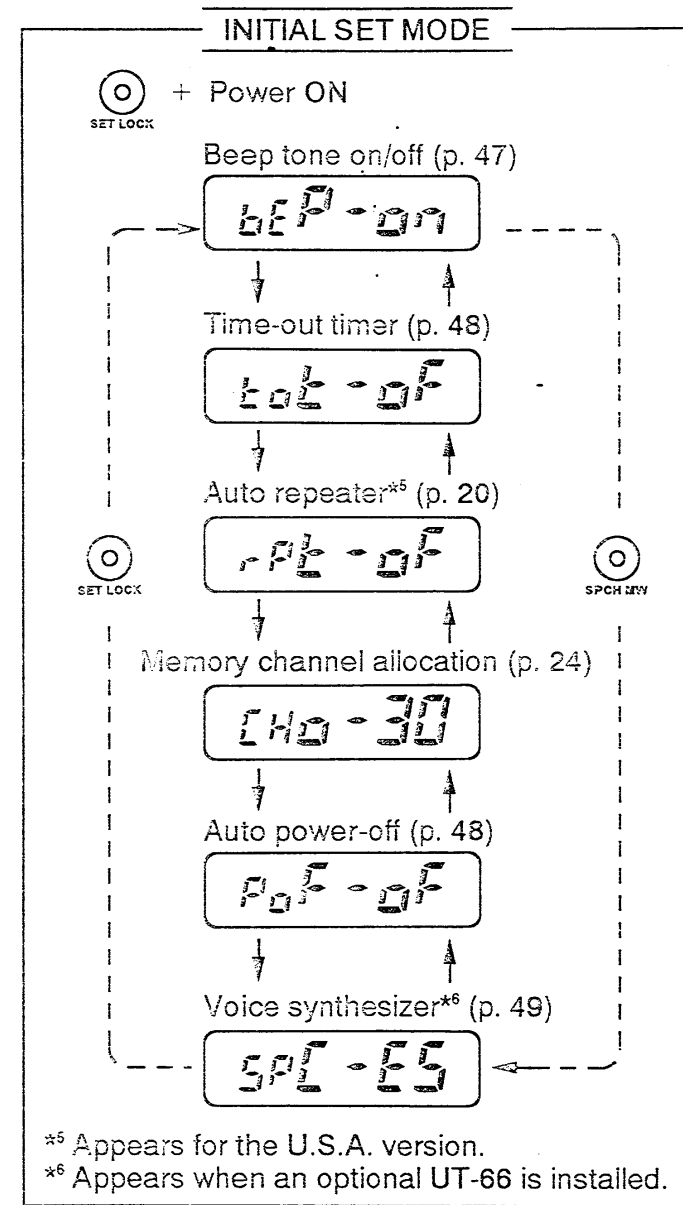
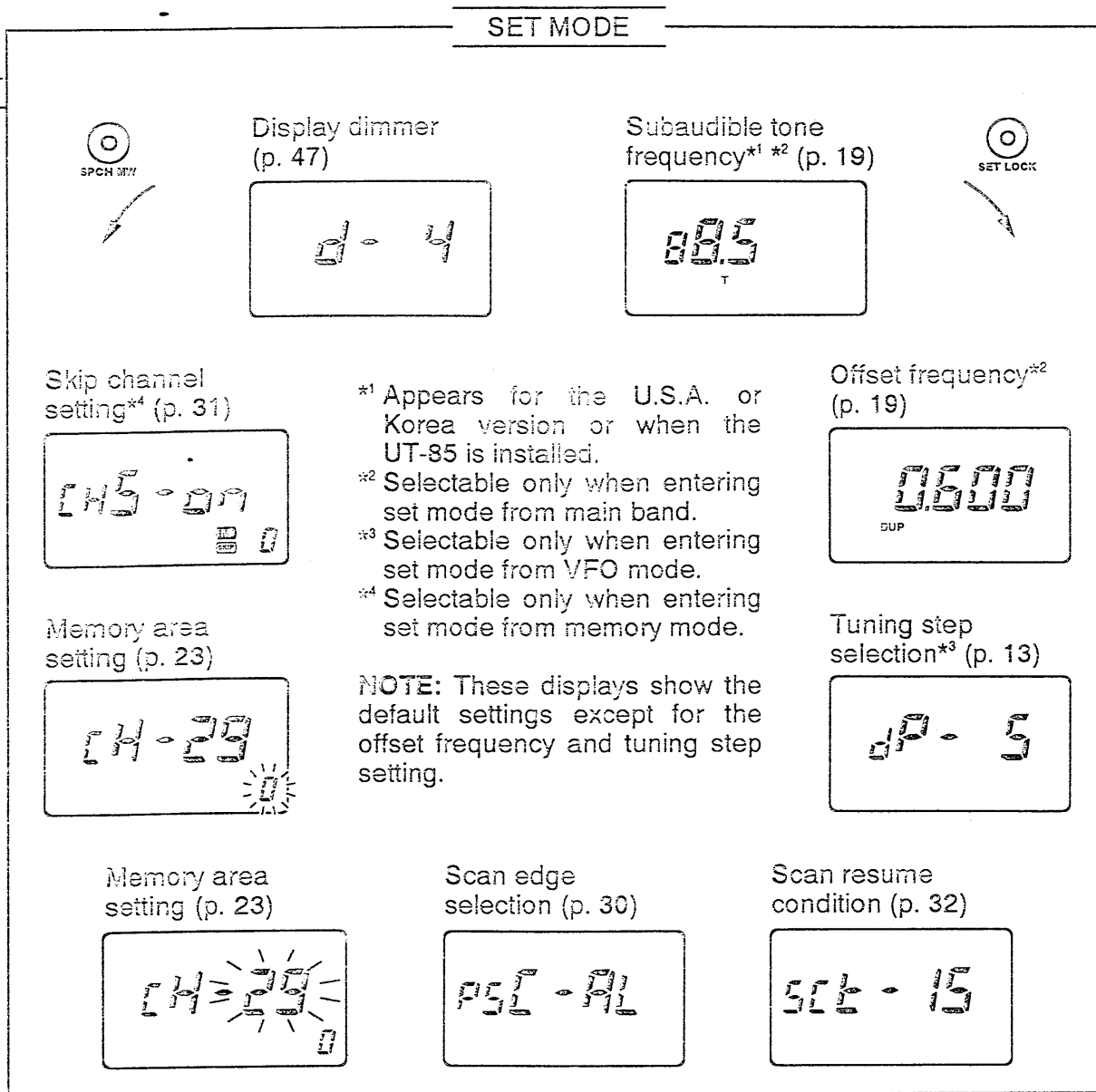

# 4

## SETTING A FREQUENCY

### ■ Using the tuning dial

- ① Select the desired band with the [BAND] switch.
- ② Rotate the tuning dial to set the frequency.
  - If VFO mode is not selected, push [V/MHz] to select VFO mode. See the mode arrangement chart on p. 11.
  - Frequency changes according to the selected tuning steps. See section at right for details.
- ③ For 1 MHz frequency setting, push [V/MHz], then rotate the tuning dial.
  - Pushing [V/MHz] for 1 sec. selects the 10 MHz tuning step in some versions.

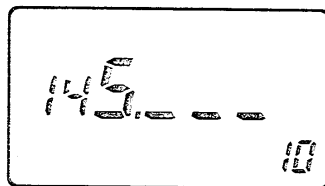

The display shows that the 1 MHz tuning step is selected.

▨ The frequency can be directly set from the HM-77/A\* HAND MICROPHONE using the Mic DTMF remote function. See p. 41 for details.

\* Optional for non-U.S.A./Korea versions.

### ■ Tuning step selection

*USING SET MODE*

Tuning steps are the minimum frequency change increments when you rotate the tuning dial or push the [UP]/[DN] keys on the microphone. Separate tuning steps can be specified for the main and receive bands. The following tuning steps are available.

- 5 kHz
- 10 kHz
- 12.5 kHz
- 15 kHz
- 20 kHz
- 25 kHz
- 30 kHz
- 50 kHz

- ① Select the desired band with the [BAND] switch.
- ② Select VFO mode with the [V/MHz] switch.
- ③ Push [SET] one or more times until "dP" appears as shown at right page.
  - Pushing [SPCH] reverses the order of selection. (p. 12)
  - Cancel pager or code squelch in advance. (pgs. 37, 38)
- ④ Rotate the tuning dial to select the desired tuning step.
- ⑤ Push [BAND] to exit set mode.

**NOTE:** For convenience, select a tuning step that matches the frequency intervals of repeaters in your area.



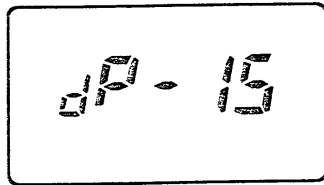

15 kHz tuning step

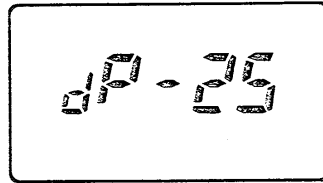

25 kHz tuning step

## ■ Using [UP]/[DN] switches

Push [UP] or [DN] to set the main or receive band's frequency according to the selected tuning steps.

- Be sure [LOCK] on the microphone is set to OFF.
- Pushing [UP] or [DN] for more than 0.5 sec. will activate a scan.
- If a scan is started, push [UP] or [DN] again to stop it.

When Up Switch Remote is in use or Mic DTMF Remote is in standby, [UP] or [DN] cannot be used for frequency setting. (pgs. 40, 41)

## ■ Lock function

To prevent accidental frequency changes and unnecessary function access, use the lock function. This function locks the tuning dial and switches electronically.

Push and hold [SET•LOCK] until "L" appears in the memory channel readout to activate the function.

- To cancel the function, push and hold [SET•LOCK] until "L" disappears.
- [PTT], [MONI] (pushing the tuning dial) and optional [SPCH] can be used while the lock function is in use. DTMF tone or DTMF memory contents can be transmitted from the HM-77/A.\*

\* Optional for non-U.S.A./Korea versions.

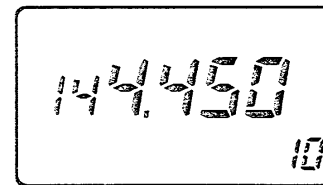

The display shows that the lock function is OFF.

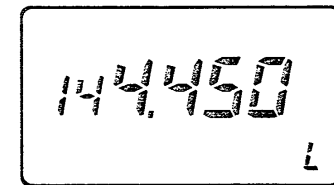

The display shows that the lock function is ON.

# 5

## BASIC OPERATION

### ■ Receiving

The transceiver can receive a 144 MHz or a 430(440) MHz band signal. For simultaneous transmitting on the main band and receiving on the receive band, see "Crossband full duplex" on p. 17.

- ① Push [VOL] for 1 sec. to turn power ON.
- ② Select the desired band with the [BAND] switch.
- ③ Set the squelch and audio levels.
  - Rotate [SQL] counterclockwise until noise is emitted. (Squelch opens.)
  - Rotate [VOL] to adjust the audio output level.
  - Rotate [SQL] clockwise until noise is muted.
- ④ Set the operating frequency. (pgs. 13, 14)
- ⑤ When receiving a signal on the set frequency, squelch opens and the transceiver emits audio.
  - "BUSY" appears and the S/Rf indicator shows the relative signal strength of the received signal.

When receiving a signal.

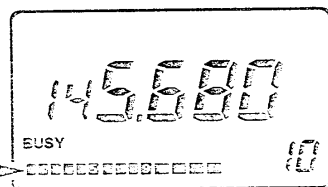

### ■ Monitor function

This function is used to listen to weak signals without disturbing the squelch setting or to open the squelch manually even when the pager, code squelch, optional pocket beep or optional tone squelch is in use.

Push and hold the tuning dial to open the squelch.

- While duplex is ON for repeater operation or crossband full duplex is ON, the transmit frequency can be monitored. (pgs. 17, 18)

Pushing the tuning dial opens the squelch.

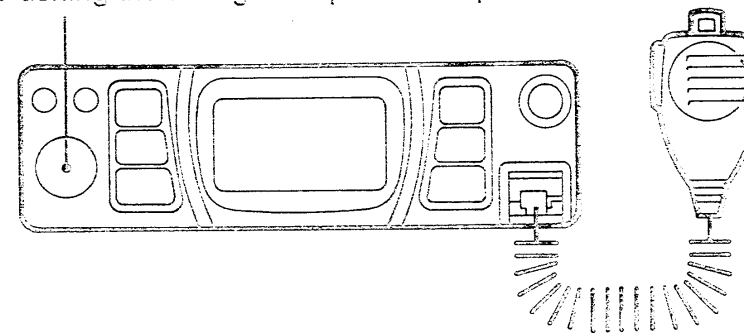

## Receive band

The receive band enables you to receive signals on the 430(440) MHz band.

Push [BAND] to select the receive band.

- "RX BAND" appears while the receive band is selected.

While the receive band is selected.

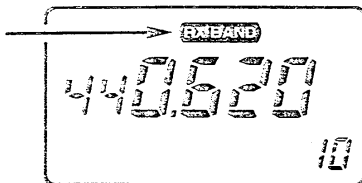

- Receiver performance on the receive band is reduced from that of a conventional transceiver. (p. 54)
- The following functions are not available for the receive band:
  - Tone encoder
  - Pocket beep
  - Tone squelch
  - Duplex setting

## Transmitting

**CAUTION:** Transmitting without an antenna may damage the transceiver.

**NOTE:** To prevent interference, listen on the frequency before transmitting by pushing the tuning dial.

- ① Select the main band with the [BAND] switch.
- ② Set the operating frequency. (pgs. 13, 14)
  - Select output power, if desired. See section on the next page for details.
- ③ Push and hold [PTT] to transmit.
  - "TX" appears.
  - The S/RF indicator shows the output power selection.
  - The operating frequency, etc. are automatically programmed into a scratch pad memory. See p. 26 for details.
- ④ Speak into the microphone using your normal voice level.
  - DO NOT hold the microphone too close to your mouth or speak too loudly. This may distort the signal.
- ⑤ Release [PTT] to return to receive.

When transmitting

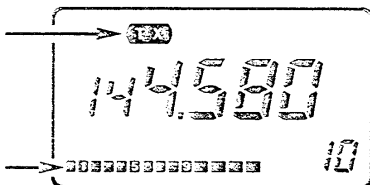

Shows the output power selection.



## 5 BASIC OPERATION

### ■ Selecting the output power

The transceiver has 3 output power levels to suit your operating requirements. Lower output power during short-distance communication may reduce interference to other stations and reduces current consumption.

Push [LOW] one or more times to select the main band output power.

- The output power can be changed while transmitting.

POWER SELECTION	S/RF INDICATOR	OUTPUT POWER
HIGH		50 W (25 W)
LOW 2 (LPo-2)	 LOW	10 W
LOW 1 (LPo-1)	 LOW	5 W (2 W)

Above values are typical. Bracketed values are for the "A/E" types.

### ■ Crossband full duplex

The transceiver can receive a receive band signal while transmitting on the main band. Using this capability, crossband full duplex operation is possible.

To prevent howling, set the volume level as low as possible.

- ① Select the main band with the [BAND] switch.
  - ② Set the transmit frequency.
    - Select VFO mode with the [V/MHz] switch.
    - Rotate the tuning dial to set the transmit frequency.
  - ③ Set the receive frequency.
    - Select the receive band with the [BAND] switch.
    - Select VFO mode with the [V/MHz] switch.
    - Rotate the tuning dial to set the receive frequency.
  - ④ When "SPT" does not appear, see "Turning the crossband full duplex ON/OFF" below.
  - ⑤ Set the same frequencies, but set your receive band as the main (transmit) band for the other transceiver.
  - ⑥ Push and hold [PTT] to operate in full duplex.
    - Transmit and receive activate simultaneously.
- ◆ **Turning the crossband full duplex ON/OFF** -
- ① Select the receive band with the [BAND] switch.
  - ② Push [BAND•SPLIT] for 1 sec. to turn the crossband full duplex function ON or OFF.
    - "SPT" appears when the crossband full duplex is ON.

## ■ Operation

A repeater amplifies received signals and retransmits them at a different frequency. When using a repeater, the transmit frequency is shifted from the receive frequency by the offset frequency. (p. 19) It is convenient to program repeater information into a memory channel. (p. 22)

- ① Select the main band with the [BAND] switch.
- ② Set the receive frequency (repeater output frequency). (pgs. 13, 14)
- ③ Push [DUP] one or more times to select –duplex or + duplex.
  - “DUP –” or “DUP” appears to indicate the transmit frequency as minus shift or plus shift, respectively.
  - The U.S.A. version has an auto repeater function. (p. 20)
- ④ Push and hold [PTT] to transmit.
  - The displayed frequency automatically changes to the transmit frequency (repeater input frequency).
  - When the repeater requires a tone, see section at right.
  - The operating condition is automatically programmed into a scratch pad memory. See p. 26 for details.
  - If “o.FF” appears, check the offset frequency. (p. 19)
- ⑤ Release [PTT] to receive.
- ⑥ Push and hold the tuning dial to check whether the other station’s transmit signal can be directly received or not.

## ■ Tone information

### SUBAUDIBLE TONE

(An optional UT-85 is necessary, except for 88.5 Hz tones, for non-U.S.A./Korea versions.)

- ① Push [DUP•TONE] for 1 sec. one or more times until only “T” appears (subaudible tone encoder ON).
  - To set the subaudible tone frequency, see “Subaudible tone” on the next page.
  - For the U.S.A. version, an auto repeater function is available. When the auto repeater function type-2 (“rPT-r2”) is selected in initial set mode, the subaudible tone encoder is automatically turned ON or OFF when the operating frequency is inside or outside of the general repeater input frequency range, respectively. (p. 20)
- ② Push [DUP•TONE] for 1 sec. a few times until “T” disappears (subaudible tone encoder OFF).

### DTMF TONES (U.S.A. and Korea versions)

Push the desired digit key on the microphone to transmit DTMF tones.

- The HM-77/A has 14 DTMF memory channels. (p. 43)

### 1750 Hz TONE (Europe and Italy versions only)

Push and hold [TONE] on the microphone for 1–3 sec. to transmit a 1750 Hz tone call signal.

- The optional HM-77/A has tone call function. (p. 46)

## 6 REPEATER OPERATION

### Subaudible tone USING SET MODE

(An optional UT-85 is required for non-U.S.A./Korea versions.)

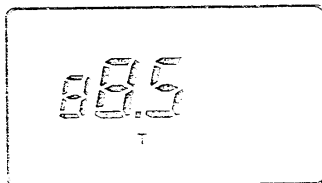

The display shows an 88.5 Hz subaudible tone frequency.

- ① Select the main band with the [BAND] switch.
- ② Select the desired mode or channel you wish to set the subaudible tone frequency to, such as VFO mode, memory/call channel or scratch pad memory.
  - The subaudible tone frequency is independently programmed into each mode or channel.
- ③ Push [SET] one or more times until "T" and a subaudible tone frequency appear on the display.
  - Pushing [SPCH] reverses the order of selection. (p. 12)
  - Cancel pager or code squelch in advance. (pgs. 37, 38)
- ④ Rotate the tuning dial to select the desired frequency.
- ⑤ Push [BAND] to exit set mode.

#### ◦ Subaudible tone frequency list (Unit: Hz)

67.0	79.7	94.8	110.9	131.8	156.7	186.2	225.7
69.3*	82.5	97.4	114.8	136.5	162.2	192.8	233.6
71.9	85.4	100.0	118.8	141.3	167.9	203.5	241.8
74.4	88.5	103.5	123.0	146.2	173.8	210.7	250.3
77.0	91.5	107.2	127.3	151.4	179.9	218.1	

\* The tone unit in the U.S.A./Korea version do not have a 69.3 Hz tone.

### Offset frequency USING SET MODE

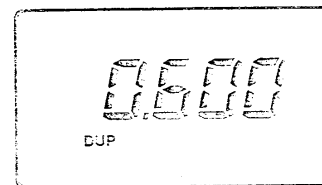

The display shows a 0.6 MHz (600 kHz) offset frequency.

- ① Select the main band with the [BAND] switch.
- ② Select the desired mode or channel you wish to set the offset frequency to, such as VFO mode, memory/call channel or scratch pad memory.
  - The offset frequency is independently programmed into each mode or channel.
- ③ Push [SET] one or more times until "DUP" and an offset frequency appear on the display.
  - Pushing [SPCH] reverses the order of selection. (p. 12)
  - Cancel pager or code squelch in advance. (pgs. 37, 38)
- ④ Rotate the tuning dial to set the desired frequency.
  - Selectable step increment is the same as the preset tuning step. (p. 13)
  - Use [V/MHz] for quick MHz setting.
- ⑤ Push [BAND] to exit set mode.

## ■ Auto repeater function

(U.S.A. version only)

The U.S.A. version automatically activates the repeater settings (DUP or DUP – and tone encoder ON/OFF) when the main band operating frequency falls within the general repeater output frequency range and deactivates them when outside of the range.

### ◇ Setting the auto repeater function

- ① Push [VOL] to turn power OFF.
- ② While pushing [SET], turn power ON to enter initial set mode.
- ③ Push [SET] twice to select the "rPt" display as shown below.
- ④ Rotate the tuning dial to turn the auto repeater function ON ("rPt-r1" or "rPt-r2") or OFF ("rPt-oF").
  - "rPt-r1" and "rPt-r2" automatically set the duplex setting and duplex/tone encoder settings, respectively.
- ⑤ Turn power OFF to set the condition and exit initial set mode.

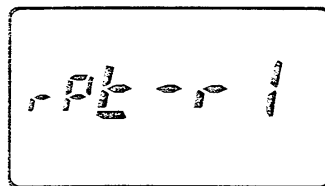

Duplex setting:  
Tone encoder:

Automatic  
Manual

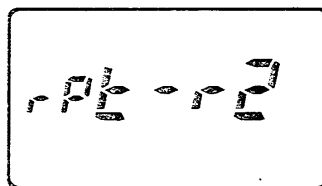

Automatic  
Automatic

## ■ Tone scan

By monitoring a signal that is being transmitted on a repeater input frequency, you can determine the tone frequency necessary to open a repeater.

An optional UT-85 is required to activate the tone scan.

- ① Select the main band with the [BAND] switch.
- ② Set the desired frequency to be checked for a tone frequency.
- ③ Push [DUP•TONE] for 1 sec., one or more times until "T SQL" appears on the function display.
- ④ Push [DTMF•SCAN] for 1 sec. to start the tone scan.
  - To change the scanning direction, rotate the tuning dial.
- ⑤ When the tone frequency is matched, the squelch opens and the tone frequency is programmed into the selected mode such as VFO, memory/call channel or scratch pad memory.
- ⑥ Push [DTMF] to stop the scan.
- ⑦ Push [DUP•TONE] for 1 sec. twice to activate the tone encoder with the detected tone frequency.

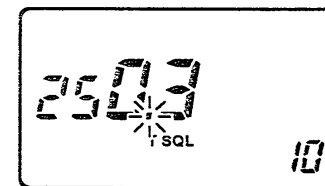

## General description

The transceiver has 30 regular memory channels plus 6 scan edge memory channels on each band; each of these can be individually programmed with the following data.

- Operating frequency (pgs. 13, 14)
- Duplex direction\*<sup>1</sup> (DUP or DUP -) (p. 18)
- Offset frequency\*<sup>1</sup> (p. 19)
- Subaudible tone frequency\*<sup>2</sup> (p. 19)
- Subaudible tone encoder ON/OFF (p. 18)
- Tone squelch ON/OFF\*<sup>3</sup> (p. 39)
- Skip information\*<sup>4</sup> (p. 31)

\*<sup>1</sup> Main band only.

\*<sup>2</sup> An optional UT-85 TONE SQUELCH UNIT is necessary for non-U.S.A./Korea versions.

\*<sup>3</sup> An optional UT-85 TONE SQUELCH UNIT is necessary.

\*<sup>4</sup> Except for the scan edge memory channels.

Memory channels can be added or subtracted to either band. Using initial set mode, 10–50 channels can be allocated to a band in 10 channel steps for a maximum of 50 channels for a given band (maximum of 60 channels for both bands combined). See p. 24 for details.

In addition, the accessible memory channel area can be restricted to speed up memory channel selection, etc. (p. 23)

## Memory channel selection

- ① Select the desired band with the [BAND] switch.
- ② Push [M/CALL] once or twice to select memory mode.
  - “**M**” appears.
- ③ Select the desired memory channel.

### Using the tuning dial:

Rotate the tuning dial to select the desired memory channel.

### Using the [UP]/[DN] switches:

Push [UP] or [DN] to change the memory channel.

- Pushing [UP] or [DN] for more than 0.5 sec. will activate memory scan. If scan starts, push [UP] or [DN] again to stop the scan.

- ④ To return to VFO mode, push [V/MHz].

“**M**” appears to indicate memory mode is selected.

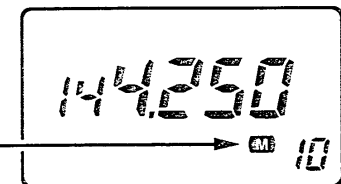

▨ The memory channel can be directly selected from the HM-77/A\* HAND MICROPHONE using the Mic DTMF remote function. See p. 41 for details.

\* Optional for non-U.S.A./Korea versions.



## ■ Programming a memory channel

VFO mode settings, including the set mode contents such as subaudible tone frequency, etc., can be programmed into a memory channel.

### ① Select the memory channel to be programmed:

- Select the desired band with the [BAND] switch.
- Select memory mode by pushing [M/CALL] once or twice. ("  " appears.)
- Rotate the tuning dial to select the memory channel.

### ② Set the desired frequency in VFO mode:

- Push [V/MHz] to select VFO mode.
- Set the desired frequency using the tuning dial.
- Set other data (e.g. offset frequency, duplex direction, subaudible tone encoder ON/OFF and its frequency), if required.

### ③ Push [SPCH•MW] for 1 sec. to program.

- 3 beeps may sound and the VFO contents (including the subaudible tone frequency, etc.) are programmed.
- Memory channel number advances when continuously pushing [SPCH•MW] for 1 sec. after programming. (p. 24)

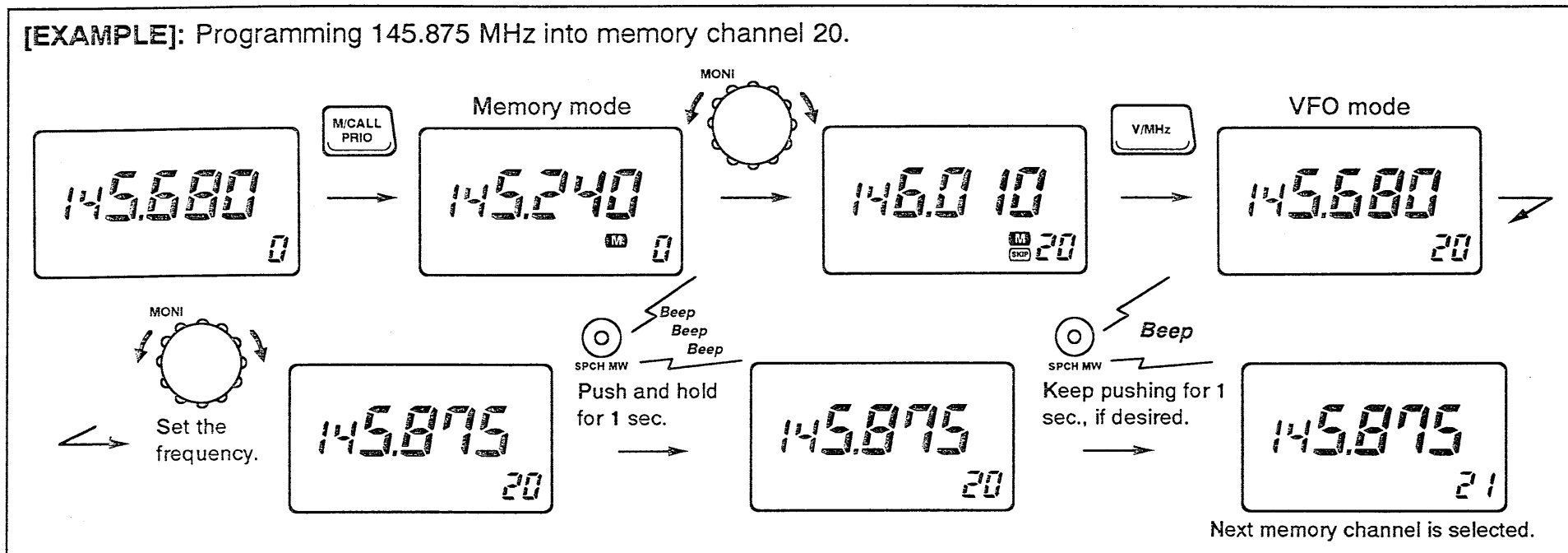

## 7 MEMORY OPERATION

### ■ Transferring memory contents

This function transfers a memory channel's contents into the VFO. This is useful when searching for signals around a memory channel's frequency and for recalling the offset frequency, subaudible tone frequency, etc.

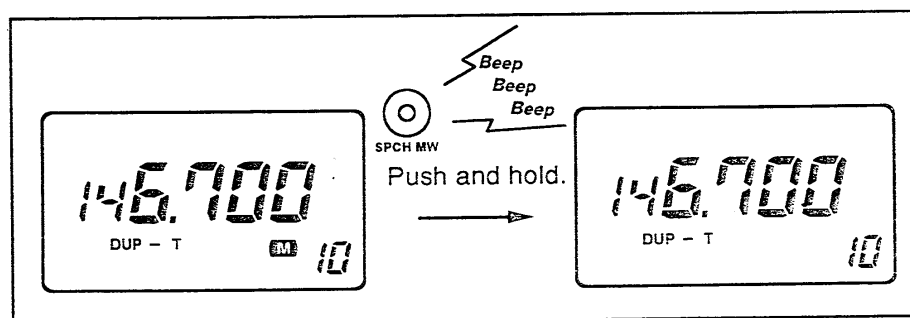

- ① Select the memory channel to be transferred:
  - Select the desired band with the [BAND] switch.
  - Select memory mode by pushing [M/CALL] once or twice. ("M" appears.)
  - Rotate the tuning dial to select the memory channel.
- ② Push [SPCH•MW] for 1 sec.
  - "M" disappears as VFO mode is automatically selected.
  - 3 beeps may sound and the memory contents (including the subaudible tone frequency, etc.) are transferred.

### ■ Memory area setting

USING SET MODE

The range of usable memory channels on each band can be specified. This function speeds up memory scan or memory channel selection with the tuning dial or [UP]/[DN] switches. Memory area setting does not clear the memory contents.

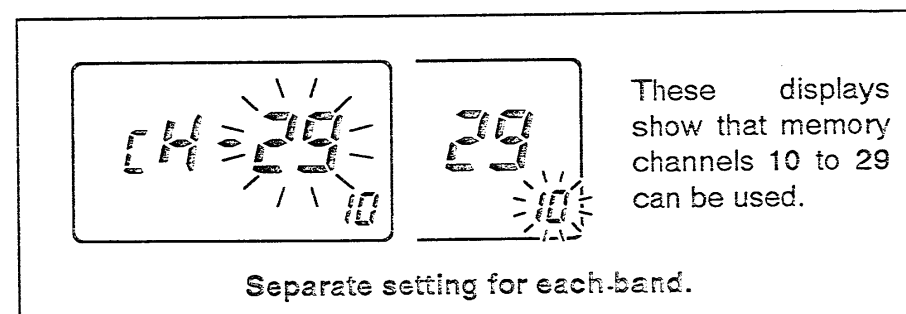

- ① Select the desired band with the [BAND] switch.
- ② Push [SET] one or more times until "CH-29" (or another number) appears and "-29" flashes as shown above.
  - Pushing [SPCH] reverses the order of selection. (p. 12)
  - Cancel pager or code squelch in advance. (pgs. 37, 38)
- ③ Rotate the tuning dial to set a desired channel number.
- ④ Push [SET]; then, rotate the tuning dial to set the other desired channel number.
  - This sets the range of available memories.
- ⑤ Push [BAND] to exit set mode.

## ■ Memory channel allocation

A total of 60 regular memory channels are available with a default setting of 30 memory channels for each band. This default allocation for each band can be changed in 10-channel steps for a maximum of 50 channels and a minimum of 10 channels (total of 60 channels for the 2 bands combined). For convenience, allocate more channels to your most-often-used band.

**NOTE:** Subtracted band memory channels will be cleared in 10-channel steps from the higher memory channels.

- ① Push [VOL] to turn power OFF.
- ② While pushing [SET], turn power ON to enter initial set mode.
- ③ Push [SET] twice (3 times for the U.S.A. version) to select "CHo" display as shown at right.
  - "CHo-30" and "M 30" (or other numbers) appear.
- ④ Rotate the tuning dial to allocate the number of memory channels (in 10 channel steps) for each band.
  - "CHo-50" and "M 10" indicates a total of 50 channels for the main band and 10 channels for the receive band. See right for an example of allocating memory channels to each band.
- ⑤ Turn power OFF to set the condition and exit initial set mode.

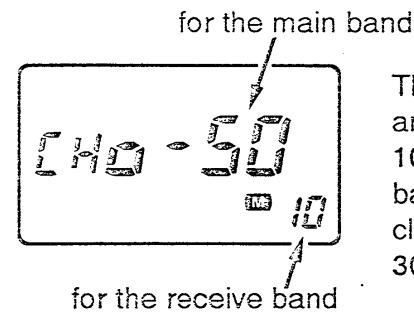

The display shows that 50 channels are allocated to the main band and 10 to the receive band. Receive band memory channels 10–29 are cleared when previously setting was 30 channels for each band.

## ■ Auto channel advance

The selected memory channel number in VFO mode automatically advances when programming a memory channel. This is useful when programming 2 or more memory channels at once.

Push and hold [SPCH•MW] for 2 sec. to program the VFO contents into the selected memory channel and advance the memory channel number.

- 3 beeps and a longer beep may sound.
- When you do not want to advance the memory channel number, release [SPCH•MW] after 3 beeps sound. (Memory channel programming is completed in approx. 0.5 sec.)

## ■ Calling up a call channel

The transceiver has a call channel on each band for quick access to a most-often-used frequency.

- ① Select the desired band with the [BAND] switch.
- ② Push [M/CALL] once or twice to select the call channel.
  - A large "C" appears.
- ③ To return to VFO or memory mode, push [V/MHz] or [M/CALL], respectively.
  - The large "C" changes to a small "c" when VFO mode is selected.

## ■ Transferring a call channel's contents

- ① Select the desired band with the [BAND] switch.
- ② Select the call channel by pushing [M/CALL] once or twice.
  - A large "C" appears.
- ③ Push [SPCH•MW] for 1 sec.
  - The large "C" changes to a small "c" as VFO mode is selected.
  - 3 beeps may sound and the call channel contents (including the subaudible tone frequency, etc.) are transferred.

## ■ Programming a call channel

In addition to an operating frequency, duplex information and subaudible tone information (tone encoder or tone squelch\*<sup>1</sup> ON/OFF and its frequency\*<sup>2</sup>) can be programmed into the call channel.

\*<sup>1</sup> An optional UT-85 is necessary.

\*<sup>2</sup> An optional UT-85 is necessary for non-U.S.A./Korea versions.

- ① Select the desired band with the [BAND] switch.
- ② Select the call channel by pushing [M/CALL] once or twice.
  - A large "C" appears.
- ③ Push [V/MHz] to select VFO mode.
  - The large "C" changes to a small "c."
- ④ Set the desired frequency using the tuning dial.
  - Set other data (e.g. offset frequency, duplex direction, subaudible tone encoder ON/OFF and its frequency), if required.
- ⑤ Push [SPCH•MW] for 1 sec. to program.
  - 3 beeps may sound and the VFO contents (including the subaudible tone frequency, etc.) are programmed.

## What is a scratch pad memory

The transceiver automatically memorizes operating frequency information, separate from regular memory channels, when transmitting on a new frequency. The 5 previously operated frequencies for the main band can be recalled.

When transmitting with a duplex setting (for repeater use), the operating frequency is stored into a separate scratch pad memory. 5 duplex scratch pad memories, separate from simplex scratch pad memories, are available for a total of 10 scratch pad memories.

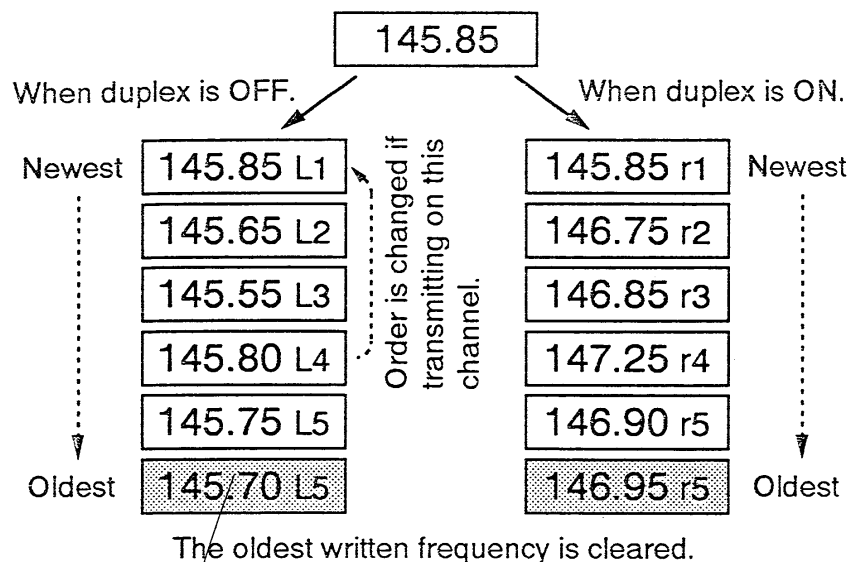

## Calling up a scratch pad memory

- ① Select the main band with the [BAND] switch.
- ② Select the call channel by pushing [M/CALL] once or twice. (A large "C" appears.)
- ③ Rotate the tuning dial clockwise or push [UP] to select a duplex scratch pad memory; rotate the tuning dial counterclockwise or push [DN] to select a simplex scratch pad memory.
  - Previously transmitted frequency and "L1"–"L5" or "r1"–"r5" appears.
  - When first applying power or after CPU resetting, scratch pad memories contain no data therefore cannot be accessed.
- ④ Push [V/MHz] to return to VFO mode or push [M/CALL] to select memory mode.

The 5th simplex or duplex scratch pad memory will be cleared when transmitting on a new frequency. If the transmit frequency is already stored in a scratch pad memory, the scratch pad memory is not cleared but the order is changed.

### Transferring a scratch pad memory

Transferring scratch pad memory can be done in a similar manner to transferring regular memory or call channel contents as described on the page at left.

# 10 SCAN OPERATION

## Scan types

Scanning searches for transmitted signals automatically and makes it easier to locate new stations for contact or listening purposes.

Each band has 3 scan types and 5 resume conditions to suit your needs.

### FULL SCAN (p. 28)

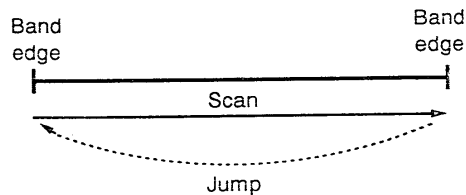

Repeatedly scans all frequencies over the entire selected band. Used as a simple default scan.

### PROGRAMMED SCAN (p. 28)

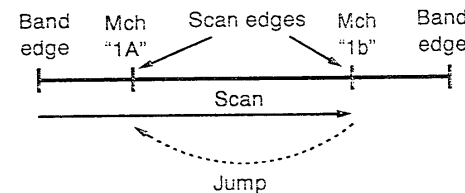

Repeatedly scans between two user-programmed frequencies. Used for checking for frequencies within a specified range such as repeater output frequencies, etc. 3 pairs of scan edges are selectable for each band.

### MEMORY SCAN (p. 30)

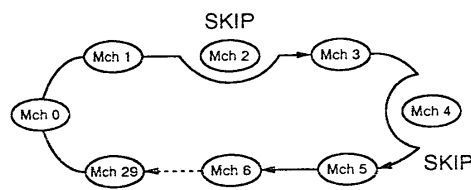

Repeatedly scans memory channels within the range of the set memory area except skip channels. Used for checking often-called channels and bypassing normally busy channels such as repeater frequencies.

### SCAN RESUME CONDITION (p. 32)

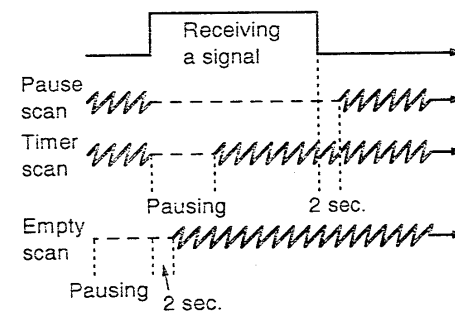

5 resume conditions are available: 3 timer scans, pause scan, empty scan. When receiving a signal, pause scan pauses until the signal disappears; timer scans pause for 5, 10 or 15 sec. Empty scan pauses until a signal appears.

## ■ Full scan and programmed scan

The procedure for full scan and programmed scan is the same. However, one or the other is activated depending on the presetting as described on p. 30.

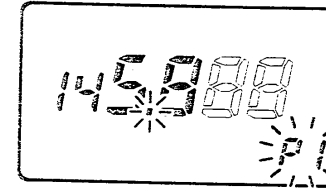

Indicates the scan edge channels "1A/1b" are selected.

- ① Select the desired band with the [BAND] switch.
- ② Select VFO mode with the [V/MHz] switch.
- ③ Set [SQL] to the point where noise is muted.
- ④ Select full scan or one of 3 programmed scan edges as described on p. 30.
- ⑤ Push [UP]/[DN] on the microphone or [DTMF•SCAN] for 1 sec. to start the scan.
  - When the optional tone squelch is in use, [DTMF•SCAN] starts the tone scan. (p. 20)
  - To change the scanning direction, rotate the tuning dial.
  - Memory channel readout shows the selected scan edges as follows:
    - "AL" : Full scan is selected.
    - "P1" : A pair of scan edge channels "1A/1b" is selected.
    - "P2" : A pair of scan edge channels "2A/2b" is selected.
    - "P3" : A pair of scan edge channels "3A/3b" is selected.
- ⑥ To stop the scan, push [UP]/[DN] or [DTMF•SCAN].

### ◇ Scan resume condition:

- When receiving a signal, scan resumes in one of the following ways:
  - after pausing 15 sec.
  - after pausing 10 sec.
  - after pausing 5 sec.
  - after the signal disappears or appears.
- The scan resume condition can be selected in set mode. (p. 32)
- While scanning, rotating the tuning dial changes the scanning direction or skips a paused frequency.

## 10 SCAN OPERATION

### ■ Programming scan edges

Scan edges can be programmed in the same way as memory channels. Memory channels "1A/1b," "2A/2b" and "3A/3b" are scan edge pairs. These 3 pairs of scan edges are available for programming.

- ① Select the desired band with the [BAND] switch.
- ② Select scan edge memory channel "1A," "2A" or "3A":
  - Select memory mode by pushing [M/CALL] once or twice.
  - Rotate the tuning dial to select memory channel "1A," "2A" or "3A."

- ③ Push [V/MHz] to select VFO mode.
- ④ Rotate the tuning dial to set the desired frequency.
- ⑤ Push and hold [SPCH·MW] for 2 sec. to program and advance the memory channel number.
  - 3 beeps and a longer beep may sound, the VFO contents are programmed and the other scan edge memory channel "1b," "2b" or "3b" is selected.
- ⑥ To program a frequency for the other scan edge memory channel "1b," "2b" or "3b," repeat steps ④, ⑤.
  - If the same frequency is programmed into a pair of scan edges and the pair is selected for programmed scan, programmed scan will not function.

[EXAMPLE]: Programming 145.30 MHz and 145.80 MHz for the main band scan edges, "1A" and "1b."

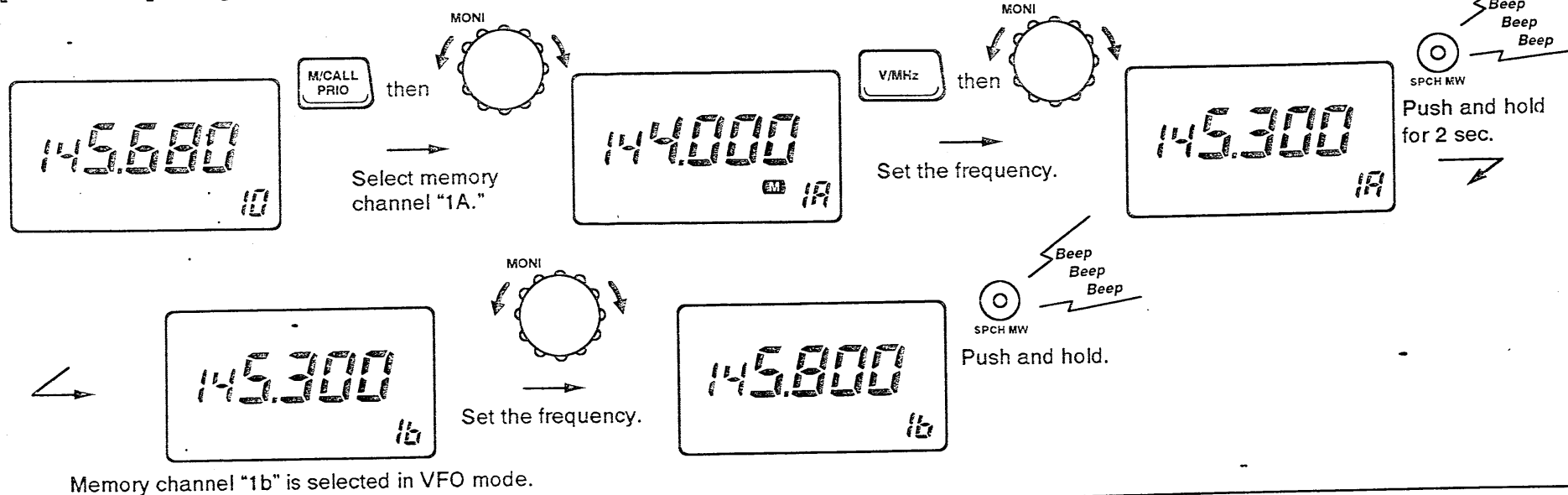



## ■ Scan edge selection

USING SET MODE

Each band has 4 pairs of scan edges. 3 pairs of scan edges are programmable and are used for scanning within a range such as repeater output frequencies, regulated simplex frequencies, etc. The remaining scan edges are the band edges for full scan and cannot be changed.

Program the scan edge frequencies and select the scan edges in advance to activate full scan or programmed scan.

- ① Select the desired band.
- ② Push [SET] one or more times until "PSC" appears as shown at right.
  - Pushing [SPCH] reverses the order of selection. (p. 12)
  - Cancel pager or code squelch in advance. (pgs. 37, 38)
- ③ Rotate the tuning dial to select full scan or one of 3 programmed scan edges.
  - "PSC-AL" : Scan operates as full scan.
  - "PSC-1A" : A pair of scan edge channels "1A/1b" is selected.
  - "PSC-2A" : A pair of scan edge channels "2A/2b" is selected.
  - "PSC-3A" : A pair of scan edge channels "3A/3b" is selected.
- ④ Push [BAND] to exit set mode.

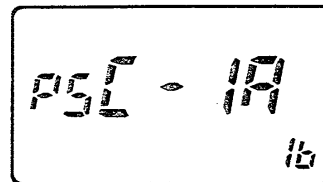

A pair of scan edge channels "1A/1b" is selected.

## ■ Memory scan

Memory scan repeatedly scans memory channels within the range of the set memory area (p. 23) except skip channels (p. 31).

- ① Select the desired band with the [BAND] switch.
- ② Select memory mode by pushing [M/CALL] once or twice.
- ③ Set [SQL] to the point where noise is muted.
- ④ Push [UP]/[DN] on the microphone or [DTMF•SCAN] for 1 sec. to start the scan.
  - When the optional tone squelch is in use, [DTMF•SCAN] starts the tone scan. (p. 20)
  - To change the scanning direction, rotate the tuning dial.
  - The scan resume condition is the same as for programmed scan. See pgs. 28, 32 for details.
  - Set the memory area, if desired. (p. 23)
- ⑤ To stop the scan, push [UP]/[DN] or [DTMF•SCAN].

**NOTE:** All memory channels are set as skip channels by default. Program more than two memory channels (p. 22) or cancel the skip function for more than two memory channels (p. 31) in advance.

## 10 SCAN OPERATION

### ■ Skip channel setting

*USING SET MODE*

The memory skip function speeds up the scan interval, checking only desired memory channels. When first applying power or after resetting the CPU, all memory channels are specified as skip channels. Programming a memory channel automatically cancels its skip setting. Set memory channels to be skipped or scanned as follows.

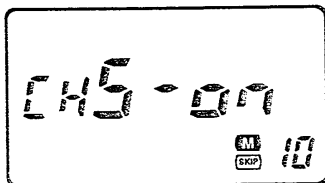

The display shows that the memory channel 10 is set as a skip channel.

Separate setting for each band.

- ① Select the desired band with the [BAND] switch.
- ② Select the desired memory channel:
  - Select memory mode by pushing [M/CALL] once or twice.
  - Rotate the tuning dial to select the memory channel.
- ③ Push [SET] one or more times until "CHS" appears as shown above.
  - Pushing [SPCH] reverses the order of selection. (p. 12)
  - Cancel pager or code squelch in advance. (pgs. 37, 38)

- ④ Rotate the tuning dial to turn the skip function ON or OFF on the selected channel.
  - "SKIP" appears : The memory channel is skipped during (CHS-on) memory scan.
  - "SKIP" disappears: The memory channel is scanned during (CHS-oF) memory scan.
- ⑤ Push [BAND] to exit set mode.

**NOTE:** The scan edge memory channels (1A-3b) cannot be specified as skip channels, however, they are skipped during memory scan, regardless.

## ■ Scan resume condition

*USING SET MODE*

The resume condition can be selected as a pause, empty or timer scan. Empty scan is useful for finding unused frequencies. The selected resume condition is valid for priority watch as well. (p. 34)

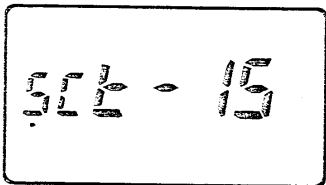

The display shows that the scan resumes 15 sec. after stopping on a signal.

Separate setting for each band.

- ① Select the desired band with the [BAND] switch.
- ② Push [SET] one or more times until "Sct" or "SCP" appears as shown above.
  - Pushing [SPCH] reverses the order of selection. (p. 12)
  - Cancel pager or code squelch in advance. (pgs. 37, 38)

- ③ Rotate the tuning dial to set the desired timer.
  - "Sct-15" : Scan pauses 15 sec. while receiving a signal.
  - "Sct-10" : Scan pauses 10 sec. while receiving a signal.
  - "Sct- 5" : Scan pauses 5 sec. while receiving a signal.
  - "SCP- 2" : Scan pauses on a signal until it disappears and then resumes 2 sec. thereafter.
  - "Sct-EP" : Scan pauses on a frequency that is not busy and resumes 2 sec. after a signal appears.
- ④ Push [BAND] to exit set mode.

# 1 1 PRIORITY WATCH

## Priority watch types

The priority watch checks for signals on a memory/call channel or the receive band VFO every 5 sec. while operating on a main band VFO frequency. The transceiver has 4 priority watch types (3 of which come in 2 flavors) to suit your needs. You can transmit on the main band VFO frequency while the priority watch operates.

The watch resumes according to the selected scan resume condition. See the previous page for settings.

### MEMORY CHANNEL WATCHES (p. 34)

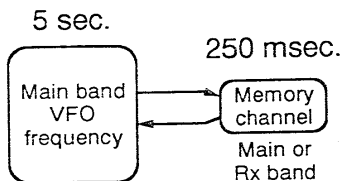

While operating on a VFO frequency, priority watch checks for a signal on the selected memory channel every 5 sec.

- A memory channel with skip information can be watched.

### CALL CHANNEL WATCHES (p. 34)

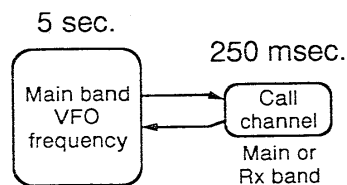

While operating on a VFO frequency, priority watch checks for a signal on the call channel every 5 sec.

### NOTE:

- The priority watch cannot be started from a scratch pad memory.
- The pager and code squelch are turned OFF when priority watch starts.
- If the optional pocket beep function is activated, the transceiver automatically selects the tone squelch function when priority watch starts.
- When "SCt-EP" is selected for the scan resume condition, the priority watch pauses on a no-signal channel. (p. 32)

### MEMORY.SCAN WATCHES (p. 34)

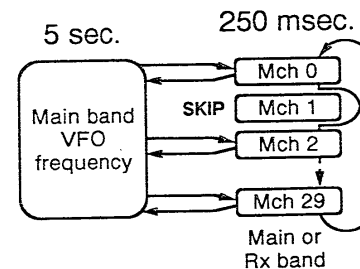

While operating on a VFO frequency, priority watch checks for signals on each memory channel in sequence.

- The memory skip function and memory area setting are useful to speedup the scan.

### RECEIVE BAND VFO WATCH (p. 34)

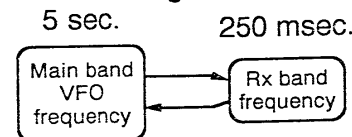

While operating on a VFO frequency, priority watch checks for a signal on the receive band VFO every 5 sec.

## ■ Priority watch operation

### ◇ Watching main band frequencies

- ① Select the main band with the [BAND] switch.
- ② Select VFO mode; then, set an operating frequency.
- ③ Set the watching channel(s).

**For memory channel watch:**

Select the desired memory channel.

**For memory scan watch:**

Select memory mode; then, push and hold [UP], [DN] or [DTMF-SCAN] for 1 sec. to start the memory scan.

**For call channel watch:**

Push [M/CALL] once or twice to select the call channel.

- ④ Push and hold [M/CALL·PRIO] for 1 sec. to start the priority watch.
  - The transceiver checks a memory or call channel frequency every 5 sec.
  - The watch resumes according to the selected scan resume condition. (p. 32)
  - While the watch is pausing, pushing [M/CALL] resumes the watch manually.
- ⑤ Push [M/CALL] while the display shows the VFO frequency to stop the watch.

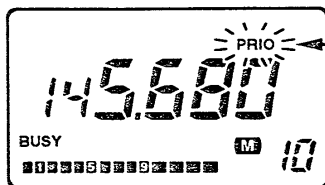

While pausing on the watching channel or frequency, "PRIO" flashes.

### ◇ Watching receive band frequencies

- ① Select the main band with the [BAND] switch.
- ② Select VFO mode; then, set an operating frequency.
- ③ Push [BAND] to select the receive band.
- ④ Set the watching frequency or channel(s).

**For receive band VFO watch:**

Select the desired frequency.

**For memory channel watch:**

Select the desired memory channel.

**For memory scan watch:**

Select memory mode; then, push and hold [UP], [DN] or [DTMF-SCAN] for 1 sec. to start the memory scan.

**For call channel watch:**

Push [M/CALL] once or twice to select the call channel.

- ⑤ Push and hold [M/CALL·PRIO] for 1 sec. to start the priority watch.
  - The transceiver checks the receive band VFO, a memory or call channel frequency every 5 sec.
  - The watch resumes according to the selected scan resume condition. (p. 32)
  - While the watch is pausing, pushing [M/CALL] resumes the watch manually.
- ⑥ Push [M/CALL] while the display shows the main band VFO frequency to stop the watch.

# 12 PAGER AND CODE SQUELCH

## General description

### ◇ Pager function

This function uses DTMF codes for paging and can be used as a "message pager" to inform you of a caller's identity even if you leave the transceiver temporarily unattended.

Personal calls and group calls are available with the pager function. Personal calls use the receiving parties' ID code for calling. The receiving parties' display shows your ID code and other stations in the party know that you called. You can also call all stations in your group using the group call.

To use the pager function in your group, all stations need the pager function.

### ◇ Code squelch

Code squelch operation provides communication with silent standby since you will only receive calls from stations which know your ID or group code.

The code squelch function transmits a 3-digit code prior to voice transmission in order to open the receiving station's code squelch.

### PAGER SIMULATION: Personal call

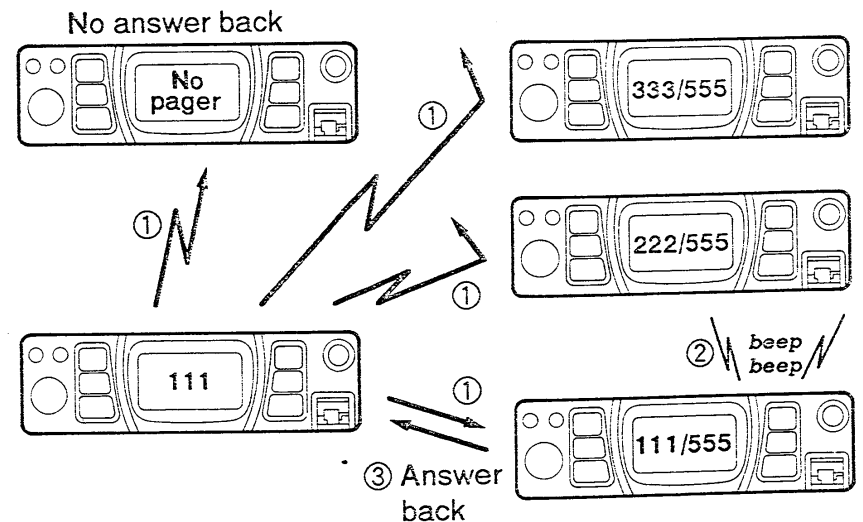

### CODE SQUELCH SIMULATION: ID code

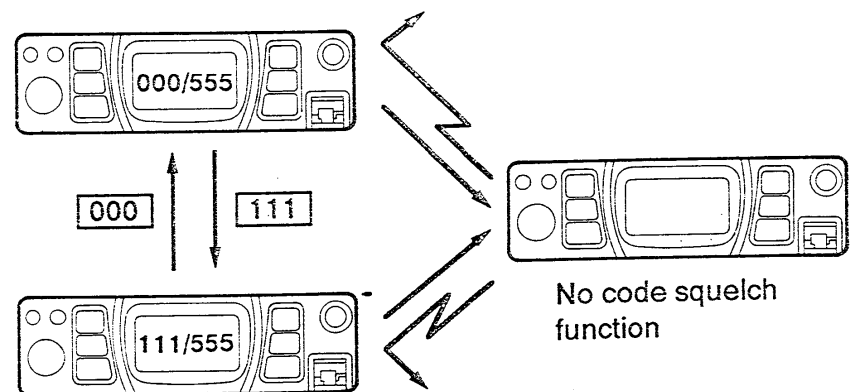

## Code programming

### ◇ Before programming

The pager and code squelch functions require ID codes and a group code. These codes are 3-digit DTMF codes and must be written in the code channels before operation.

### ◇ Code channel assignment

ID OR GROUP CODE	CODE CHANNEL NUMBER	"RECEIVE ACCEPT" OR "RECEIVE INHIBIT"
Your ID code	0	"Receive accept" only.
Other parties' ID code	1-5	"Receive inhibit" should be programmed in each channel.
Group code	One of 1-5	"Receive accept" must be programmed.
Memory space*	P	"Receive inhibit" only.

\* Code channel P automatically memorizes an ID code when receiving a pager call. The contents in channel P cannot be changed manually.

### ◇ Programming

- ① Push [DTMF] to turn the pager function ON.
  - "P" appears in place of the 100 MHz digit.
- ② Push [SET] to select the code channel setting display.
- ③ Rotate the tuning dial to select the desired code channel, 0-5.
  - Code channel P cannot be used for programming.
- ④ Push [SET] or [SPCH] to select the digit to be programmed.
- ⑤ Rotate the tuning dial to set the digit.
- ⑥ Repeat ④ and ⑤ until the last digit is programmed.
- ⑦ Push [DTMF] to set the code channel for "receive inhibit" or "receive accept."
  - When "receive inhibit" is set, "SKIP" appears.
  - Code channel 0 cannot be set as "receive inhibit."
- ⑧ Push [BAND] to exit the setting display.

#### RECEIVE ACCEPT AND INHIBIT

Code channels 1-5 can store the transmit codes for personal calls with other parties and the group codes for group calls.

The group codes should be programmed as "receive accept" to receive all calls from your parties' members.

If transmit codes are not programmed as "receive inhibit," the transceiver accepts calls directed to other parties and your answer back may confuse your party members – this is not a selective calling system. Therefore, transmit codes should be programmed as "receive inhibit" so the transceiver rejects calls directed to other parties.

### ■ Pager operation

#### ◇ Calling a specific station

- ① Set the main band frequency for your pager call.
  - The pager function can be operated using crossband full duplex. (p. 17)
- ② Push [DTMF] to turn the pager function ON.
  - "P" appears in place of the 100 MHz digit.
  - An optional tone squelch can be used together with the pager function. (p. 39)
- ③ Select the desired code channel:
  - Push [SET].
  - Rotate the tuning dial to select the code channel.
  - Push [BAND] to exit the setting display.
- ④ Push [PTT] to transmit the pager code.
- ⑤ Wait for an answer back.
  - When the transceiver receives an answer back code, the function display shows the other party's ID or group code and beeps. (p. 38)
- ⑥ After confirming a connection, push [BAND] to display the operating frequency.
- ⑦ Push [DTMF] once to select code squelch or 3 times to select the non-selective calling system.
  - Be sure that "REMO" is not displayed when the non-selective calling system is selected.

#### ◇ Waiting for a call from a specific station

- ① Set a frequency to wait for a pager call.
  - The receive band can be used only to wait for a call.
- ② Push [DTMF] to turn the pager function ON.
  - "P" appears in place of the 100 MHz digit.
  - An optional tone squelch can be used together with the pager function. (p. 39)
- ③ Wait for a call.
  - When receiving a call, the other party's ID or group code appears; " ((••)) " and the channel number flash as shown on the next page.
- ④ Push [PTT] to send an answer back and display the operating frequency.
  - While waiting for a call on the receive band with crossband full duplex function ON, the answer back call is transmitted on the main band.
- ⑤ Push [DTMF] once to select code squelch or 3 times to select the non-selective calling system.
  - Be sure that "REMO" is not displayed when the non-selective calling system is selected.



**PERSONAL CALLS**

This display appears when you are called with your ID code and the calling station's ID code is 263.

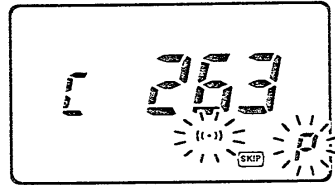
**GROUP CALLS**

This display appears when you are called with the group code, 123, and 123 has been programmed into code channel 5.

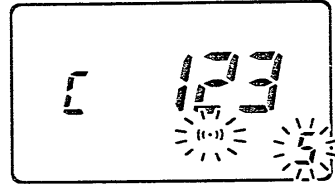
**ERROR INFORMATION**

When the transceiver receives an incomplete signal, "E" appears.

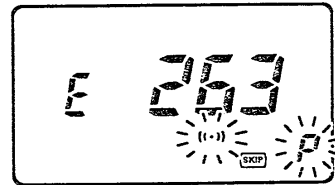

## ■ Code squelch operation

- ① Set a frequency for code squelch operation.
  - When selecting the receive band with the crossband full duplex function ON, crossband code squelch can be used. (p. 17)
- ② Push [DTMF] twice to turn the code squelch ON.
  - "C" appears in place of the 100 MHz digit as shown below.
  - An optional tone squelch can be used together with the code squelch. (p. 39)

"C" appears in place of the 100 MHz digit.

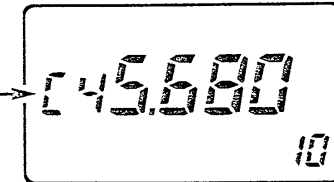

- ③ Select the desired code channel:
  - Push [SET].
  - Rotate the tuning dial to select the code channel.
  - Push [BAND] to exit the setting display.
- ④ Operate the transceiver in the normal way (push [PTT] to transmit; release [PTT] to receive).
  - Prior to voice transmission, a 3-digit transmit code is sent each time [PTT] is pushed in order to open the receiving station's code squelch.
- ⑤ To cancel the code squelch, push [DTMF] twice.
  - The display shows the operating frequency and "REMO" does not appear.

## ■ Pocket beep operation

To operate the pocket beep function, an optional UT-85 is necessary. See p. 50 for installation.

### ◇ Waiting for a call from a specific station

- ① Set a main band frequency to wait for a call.
- ② Program the subaudible tone frequency in set mode.
  - See p. 19 for programming details.
- ③ Push and hold [DUP·TONE] for 1 sec., several times until "T SQL ((·))" appears on the function display.
  - Turn OFF the pager or code squelch to activate the pocket beep. (pgs. 37, 38) The pocket beep cannot be used in combination with the pager or code squelch.
- ④ When a signal with the correct tone is received, the transceiver emits beep tones for 30 sec. and "((·))" flashes.
- ⑤ Push [PTT] to answer or push the tuning dial to stop the beeps.
  - Tone squelch is automatically selected.
- ⑥ Push and hold [DUP·TONE] for 1 sec. to cancel the function.

### ◇ Calling a waiting station using pocket beep

A subaudible tone matched with the station's tone frequency is necessary. Use the tone squelch at right or a subaudible tone encoder (p. 19, optional except for 88.5 Hz for non-U.S.A./Korea versions).

## ■ Tone squelch operation

The tone squelch opens only when receiving a signal with the same pre-programmed subaudible tone. You can silently wait for a call from group members using the same tone. This function can be activated on the main band only.

- ① Select the main band with the [BAND] switch.
- ② Set the operating frequency.
- ③ Program the subaudible tone frequency in set mode.
  - See p. 19 for programming details.
- ④ Push and hold [DUP·TONE] for 1 sec., several times until "T SQL" appears in the function display.
  - The code squelch can be used together with the tone squelch. (p. 38)
- ⑤ When the received signal includes the correct tone, the squelch opens and the signal can be heard.
  - When the received signal includes an incorrect tone or no tone, the squelch does not open, however, the S/Rf indicator indicates the signal strength.
  - To open the squelch manually, push and hold the tuning dial.
- ⑥ Operate the transceiver in the normal way (push [PTT] to transmit; release [PTT] to receive).
- ⑦ To cancel the tone squelch, push and hold [DUP·TONE] for 1 sec.
  - "T SQL" disappears from the function display.

## Assigning a function to the [UP] switch

The [UP] switch on the microphone can be programmed to control one of the switches on the front panel. By using this function, you can easily and quickly access an often-used switch without stretching to reach the transceiver front panel.

- ① Push [VOL] to turn power OFF.
- ② Be sure that the [LOCK] switch on the microphone is set to the OFF position.
- ③ While pushing [UP] on the microphone and the desired switch on the front panel, turn power ON.
  - The [UP] switch functions as the desired switch, including its secondary function (when pushing and holding [UP]).
- ④ To cancel this function, turn power OFF; then, while pushing [UP], turn power ON.

- This function cannot be activated when Mic DTMF remote is in standby. (pgs. 41, 42)
- Once the [UP] switch is programmed, the [DN] switch functions as a scan start switch; and, the tuning dial changes the scanning direction.

### [EXAMPLE]

The following example shows how to program [UP] on the microphone to function as [M/CALL].

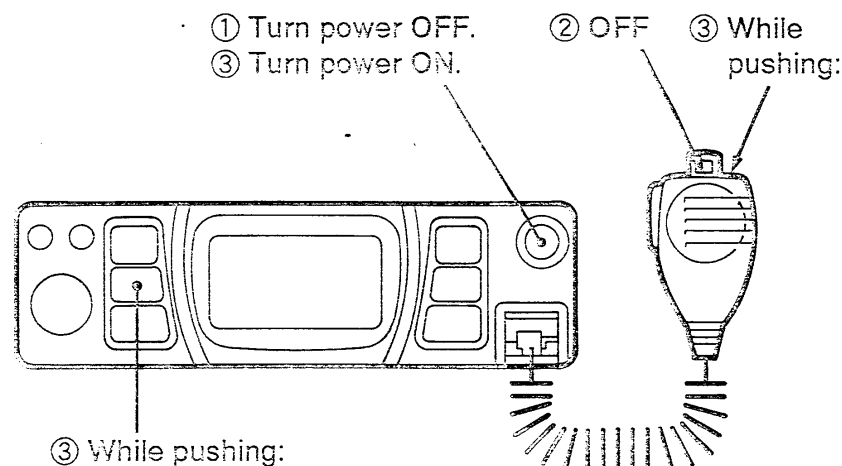

- ① Push [VOL] to turn power OFF.
- ② Set the [LOCK] switch OFF.
- ③ While pushing [UP] and [M/CALL], turn power ON.
  - The [UP] switch functions as the [M/CALL•PRIO] switch.
  - The [DN] switch functions as the scan start/stop switch.

# 15 MIC DTMF REMOTE

HM-77/A is required.

To operate Mic DTMF Remote, an HM-77/A is necessary. The HM-77/A is optional for non-U.S.A./Korea versions. Attach the supplied microphone sheet to the HM-77/A keyboard before operation.

- ① Push [DTMF] 3 times to select standby for the remote control.
  - "REMO" appears.
- ② Push [UP] on the microphone to activate Mic DTMF Remote.
  - [LOCK] on the microphone must be set OFF.
  - "REMO" flashes.
- ③ Push the desired key on the microphone as described in the table on the page at right.
- ④ Push [UP] again to cancel the function.
  - "REMO" stops flashing. The transceiver enters the standby condition for remote control.
- ⑤ Push [DTMF] to cancel standby for the remote control.
  - "REMO" disappears.

- Up Switch Remote cannot be activated while "REMO" appears or flashes. (p. 40)
- The tuning dial and all switches including the PTT switch are locked while "REMO" flashes.
- Scan cannot operate while "REMO" flashes. [DN] starts scanning when "REMO" appears.

- The DTMF memory channel of the HM-77/A may be useful for Mic DTMF Remote. See pgs. 43–45 for details.

## [EXAMPLE]:

Setting the operating frequency to 145.8125 MHz (when the VHF band tuning step is 12.5 kHz).

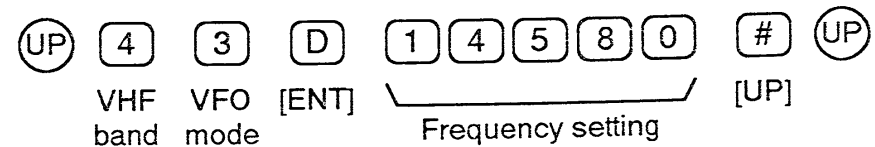

## [EXAMPLE]:

Setting the operating memory channel to 5 (receive band).

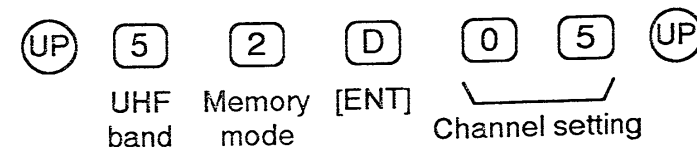

KEY	DESCRIPTION	KEY	DESCRIPTION
[1] (CALL)	Selects the call channel.	[B]	No function.
[2] (MR)	Selects memory mode.	[C] (SPEECH)	Announces the displayed frequency when an optional UT-66 is installed.
[3] (VFO)	Selects VFO mode.	[D] (ENT)	Erases the frequency and sets the digit stand-by condition. Enter a frequency using 5 digits or a memory channel number using 2 digits.
[4] (VHF)	Selects the VHF (main) band.	[0]–[9] (after pushing [D])	Enters a frequency up to the 10 kHz digit* <sup>1</sup> or enters memory channels (0–49* <sup>2</sup> ).
[5] (UHF)	Selects the UHF (receive) band.	[#] (UP)	Increases the operating frequency in preset tuning steps or the memory channel.
[6] (HIGH)	Selects high power for the main band.	[*] (DOWN)	Decreases the operating frequency in preset tuning steps or the memory channel.
[7] (V•MONI)	Opens and closes the squelch. The transmit frequency can be monitored while duplex or crossband full duplex is ON.		
[8] (U•MONI)			
[9] (LOW)	Selects low power 1 for the main band.		
[0] (MUTE)	Mutes audio signals.		
[A] (CLR)	Clears input digits and retrieves the previous key input.		

\*<sup>1</sup> When the entered frequency is outside of the frequency coverage, the input digit will be cleared.

\*<sup>2</sup> To select a scan edge memory channel (1A–3A, 1b–3b), select memory channel 0 or 29 (minimum or maximum memory channel); then, push [\*] (DN) or [#] (UP), respectively. When the entered memory channel is outside of the memory area, the input digit will be cleared.

# 16 DTMF MEMORY OPERATION

HM-77/A is required.

## ■ General

The HM-77/A is equipped with 14 DTMF code memory channels and a re-dialing function for automatic DTMF transmission. Up to a 22-digit code can be memorized into each DTMF memory in the microphone. The HM-77/A is optional for non-U.S.A./Korea versions.

## ■ Mode types

The microphone has 4 different mode types as follows:

- ① **Normal mode**  
A DTMF code is transmitted when a digit key is pushed.
- ② **Memory write mode**  
Used when writing DTMF codes into a DTMF memory channel in the microphone.
  - The active indicator flashes rapidly.
- ③ **Memory read mode**  
Used when reading DTMF codes from a DTMF memory channel in the microphone.
  - The active indicator lights continuously.
- ④ **Re-dial mode**  
Used when recalling the last-transmitted DTMF memory.
  - The active indicator flashes slowly.

## ■ Writing a DTMF memory

- ① Push [MW] on the microphone to select the memory write mode.
  - The active indicator flashes rapidly.
- ② Push and hold the PTT switch until step ⑤.
- ③ Push the desired DTMF memory channel number [0]–[9] or [A]–[D] while continuing to push the PTT switch.
  - The active indicator goes out.
- ④ Push the desired DTMF digits to be programmed while continuing to push the PTT switch.
  - Up to 22 digits can be programmed.
- ⑤ Release the PTT switch.
  - The active indicator flashes rapidly.
- ⑥ Push [MW] to return to the normal mode.
  - The active indicator goes out.

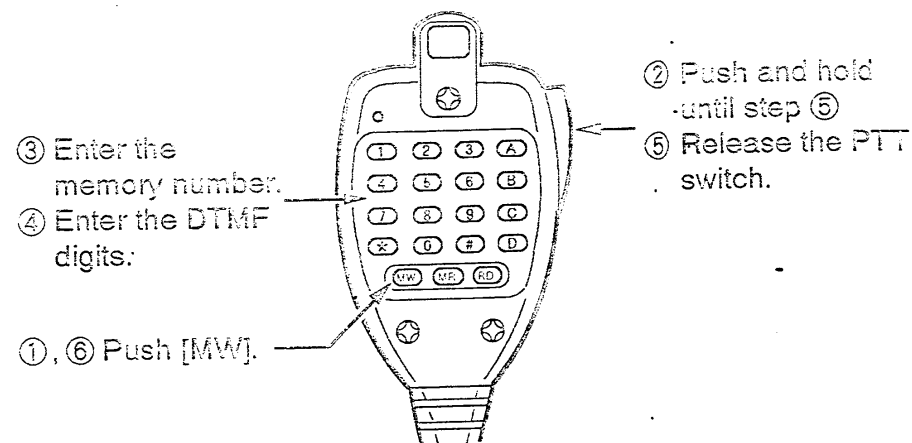

## ■ Transmitting memory data

- ① Push [MR] to select the memory read mode.
  - The active indicator lights.
- ② Push the desired DTMF memory channel number [0]–[9] or [A]–[D].
  - The memorized DTMF code is automatically transmitted.
  - The active indicator flashes while transmitting.
- ③ Push [MR] to return to the normal mode.
  - The active indicator goes out.

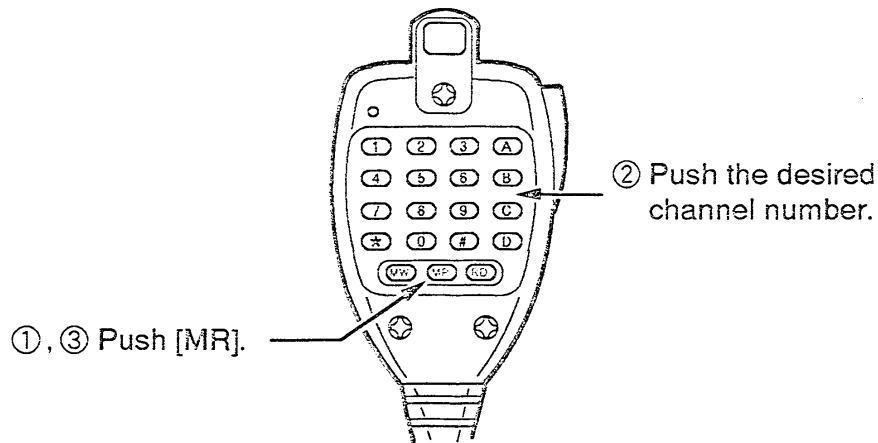

## ■ Clearing memory data

### ◇ Clearing one channel

- ① Push [MW] on the microphone to select the memory write mode.
  - The active indicator flashes rapidly.
- ② While pushing the PTT switch, push the desired memory channel key to be cleared.
  - The active indicator goes out.
- ③ Release the PTT switch.
  - The active indicator flashes rapidly.
- ④ Push [MW] to return to the normal mode.
  - The active indicator goes out.

### ◇ Clearing all channels (microphone CPU resetting)

- ① Push [VOL] to turn the transceiver power OFF.
- ② Push and hold [MW] and [MR] on the microphone.
- ③ Turn power ON to reset the CPU in the microphone.

## 16 DTMF MEMORY OPERATION

### ■ Re-dial function

To enable quick transmission of a previously transmitted DTMF code, a re-dial memory channel automatically memorizes the last-transmitted DTMF code (up to 22 digits) sequence.

#### ◇ Manual re-dial

The last-transmitted DTMF code can be transmitted by manual key operation.

- ① Push and hold the PTT switch.
- ② Push [RD] to transmit the last-transmitted DTMF codes.
  - The active indicator flashes while transmitting DTMF codes.

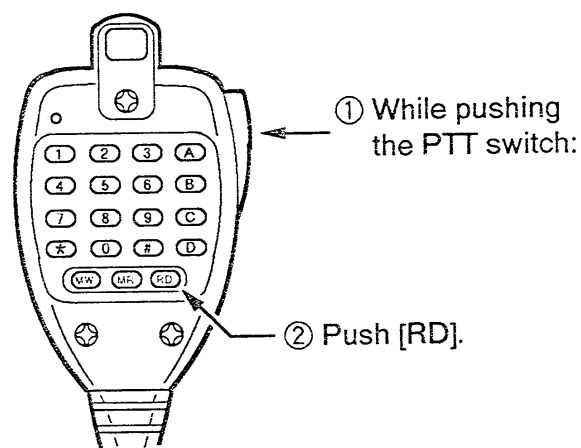

#### ◇ Auto re-dial

The last-transmitted DTMF code can be automatically transmitted at each push of the PTT switch.

- ① Push [RD] to select the re-dial mode.
  - The active indicator flashes slowly.
- ② At each push of the PTT switch, the last-transmitted DTMF code is transmitted.
- ③ Push [RD] to cancel the function and return to the normal mode.
  - The active indicator goes out.

#### ◇ Writing a re-dial memory

Although last-transmitted DTMF codes are automatically written into a re-dial memory, manual writing without transmission is also possible.

Push [RD] instead of the DTMF memory channel number key in "Writing a DTMF memory" step ③. (p. 43)

Once the transmission is interrupted while pushing the DTMF digits, the re-dial memory re-starts programming from the next digit.



## ■ 1750 Hz tone call

Some European repeaters require a 1750 Hz tone before voice transmission to open the repeater circuit. The HM-77/A has such a tone call function.

- ① Push [MR] to select the memory read mode.
  - The active indicator lights.
- ② Push and hold [#] to transmit a 1750 Hz tone call signal.
  - The [\*] key also transmits the tone for approx. 0.5 sec.
- ③ Push [MR] to return to the normal mode.

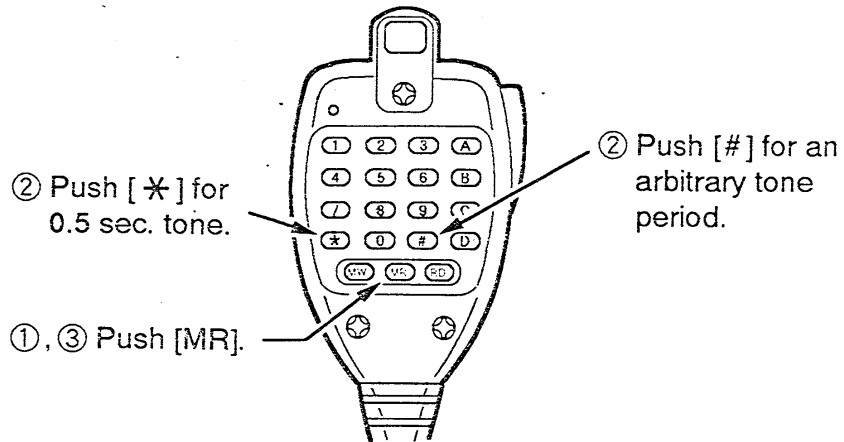

# 17 OTHER FUNCTIONS

## ■ Display dimmer setting

USING SET MODE

Adjust the intensity to suit lighting conditions and personal preference.

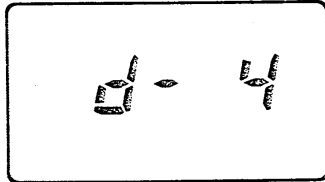

The display shows that intensity is set for "d-4" (brightest).

- ① Push [SET] one or more times until one of "d-1"—"d-4" appears as shown above.
  - Pushing [SPCH] reverses the order of selection. (p. 12).
  - Cancel pager or code squelch in advance. (pgs. 37, 38)
- ② Rotate the tuning dial to set the desired intensity.
  - The intensity level can be selected from 1 of 4 steps, d-1 (Dark) to d-4 (Bright).
- ③ Push [BAND] to exit set mode.

## ■ Beep tone on/off

You can select silent operation by turning beep tones OFF or you can select to have confirmation beeps sound at the push of a switch by turning beep tones ON.

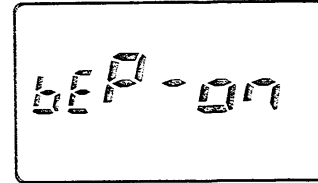

The display shows that beep tones are turned ON.

- ① Push [VOL] to turn power OFF.
- ② While pushing [SET], turn power ON to enter initial set mode.
  - "bEP" appears.
  - If "bEP" doesn't appear, push [SET] or [SPCH] one or more times until it does. (p. 12).
- ③ Rotate the tuning dial to select the condition.
  - "bEP-oF" : Beep tones are turned OFF.
  - "bEP-on" : Beep tones are turned ON.
- ④ Turn power OFF to exit initial set mode.

## ■ Time-out timer

To prevent continuous transmission with the crossband full duplex function, etc., the transceiver has a time-out timer. This timer turns a transmission OFF 3, 5, 15 or 30 min. after it starts. This timer can be cancelled.

Approx. 10 sec. before the time-out time elapses, the transceiver emits a beep tone.

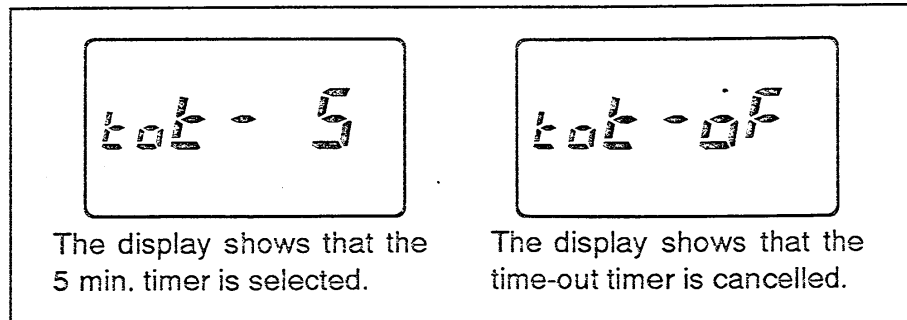

- ① Push [VOL] to turn power OFF.
- ② While pushing [SET], turn power ON to enter initial set mode.
- ③ Push [SET] to select the "tot" display as shown above.
- ④ Rotate the tuning dial to select the desired time-out time to 3, 5, 15, 30 min. or turn the timer OFF ("oF").
- ⑤ Turn power OFF to exit initial set mode.

## ■ Auto power-off

The auto power-off function conveniently turns the transceiver power OFF after a preset time in which no operations are performed. In this way, when you forget to turn the power OFF, the transceiver automatically turns OFF itself, thereby conserving battery power.

The time can be set to 30 min., 1 hr., 2 hr. or turned OFF. The selected time is retained even when the transceiver is turned OFF by the auto power-off function. To cancel the function, select "oF" in step ④ below.

- ① Push [VOL] to turn power OFF.
- ② While pushing [SET], turn power ON to enter initial set mode.
- ③ Push [SET] 3 times (4 times for the U.S.A. version) to select the "PoF" display as shown at right.
- ④ Rotate the tuning dial to select the desired auto power-off time to 30 min., 1 hr., 2 hr. or turn the timer OFF ("oF").
  - "AO" appears when an auto power-off time is set.
- ⑤ Turn power OFF to exit initial set mode.

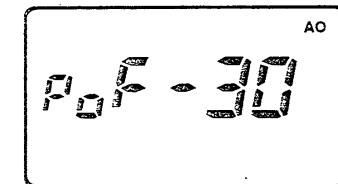

The display shows that the 30 min. timer is selected.

## 17 OTHER FUNCTIONS

### ■ Optional voice synthesizer

The transceiver announces the displayed frequency in English or Japanese when an optional UT-66 VOICE SYNTHESIZER UNIT is installed. This function can be activated even when the frequency lock function is turned ON. See the next page for installation.

Push [SPCH] to announce the displayed frequency.

- While monitoring with duplex ON, the transceiver announces the transmit frequency.
- 4 types of speech conditions are available as follows.

#### ◇ Speech condition setting

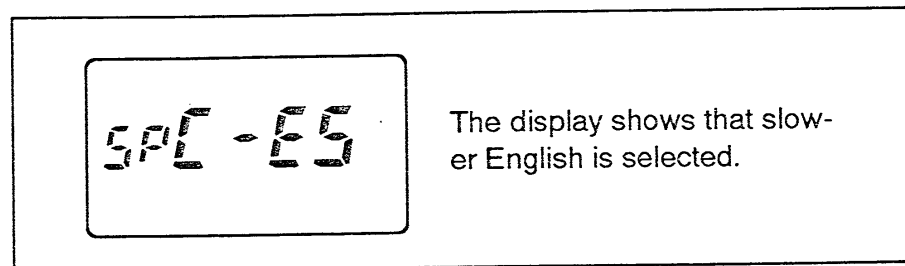

- ① Push [VOL] to turn power OFF.
- ② While pushing [SET], turn power ON to enter initial set mode.
- ③ Push [SPCH] to select the "SPc" display as shown above.
- ④ Rotate the tuning dial to select the condition.

DISPLAY	SPEECH CONDITION
SPC-ES	Slower English
SPC-EF	Faster English
SPC-JS	Slower Japanese
SPC-JF	Faster Japanese

- ⑤ Turn power OFF to exit initial set mode.

### ■ Demonstration display

A demonstration function is available at power ON. This function gives you a quick visual introduction to the function display indicators.

- ① While pushing [SET] and the tuning dial, push [VOL] to turn power ON.
  - The transceiver cycles through a visual tour of the function display indicators.
- ② Push any switch to exit demonstration mode and enter the normal operating condition temporary.
  - The transceiver automatically returns to demonstration mode after 2 min. in which no operations are performed.
  - The condition remains activated even when the power is turned OFF and ON again. Perform step ① to cancel.

## Optional unit installation

There are 2 types of optional internal units available.

- **UT-66 VOICE SYNTHESIZER UNIT** (p. 49)  
Announces the displayed frequency in English or Japanese.
- **UT-85 TONE SQUELCH UNIT** (pgs. 19, 39)  
Allows you to operate a repeater that requires a sub-audible tone\* for access, and provides pocket beep and tone squelch functions.

\* U.S.A./Korea versions : Built-in.

Other versions : 88.5 Hz only.

For installation, proceed as follows:

- ① Turn power OFF, then disconnect the DC power cable.
- ② Unscrew the 4 screws, then remove the top cover as shown in the diagram at right. (Fig. 1)
- ③ Install the optional unit as shown in the diagram at right. (Fig. 2)
- ④ Replace the top cover and screws, then connect the DC power cable.

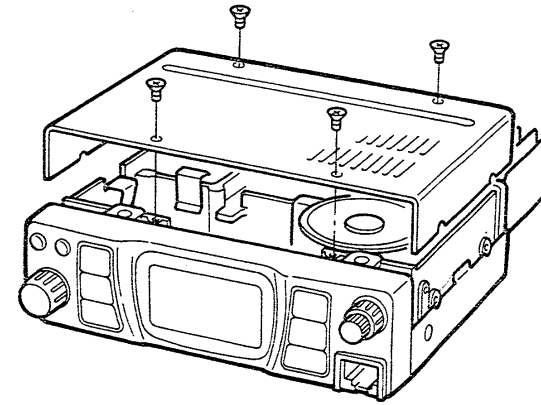

(Fig. 1)

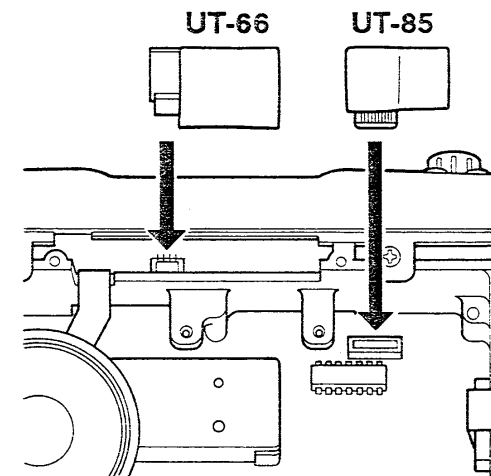

(Fig. 2)

# 18 MAINTENANCE

## ■ Troubleshooting

If your transceiver seems to be malfunctioning, please check the following points before sending it to a service center.

PROBLEM	POSSIBLE CAUSE	SOLUTION	REF.
<ul style="list-style-type: none"> <li>No power comes on.</li> </ul>	<ul style="list-style-type: none"> <li>Power connector has a poor contact.</li> <li>Polarity of the power connection is reversed.</li> <li>Blown fuse.</li> </ul>	<ul style="list-style-type: none"> <li>Check the connector pins.</li> <li>Reconnect the power cable observing the proper polarity. Replace the fuse, if damaged.</li> <li>Check the cause, then replace the fuse.</li> </ul>	<p>—</p> <p>pgs. 9, 52 p. 52</p>
<ul style="list-style-type: none"> <li>No sound comes from the speaker.</li> </ul>	<ul style="list-style-type: none"> <li>Volume level is low.</li> <li>The squelch level is set too tight.</li> <li>The pager, code squelch, optional pocket beep or optional tone squelch is turned ON.</li> </ul>	<ul style="list-style-type: none"> <li>Rotate [VOL] clockwise.</li> <li>Set the squelch to the threshold point.</li> <li>Turn the appropriate function OFF.</li> </ul>	<p>p. 15</p> <p>p. 15</p> <p>pgs. 37–39</p>
<ul style="list-style-type: none"> <li>Sensitivity is low and only strong signals are audible.</li> </ul>	<ul style="list-style-type: none"> <li>Antenna feed line or the antenna connector solder has a poor contact or is short circuited.</li> </ul>	<ul style="list-style-type: none"> <li>Check, and if necessary, replace the feed line or solder the antenna connector again.</li> </ul>	<p>p. 10</p>
<ul style="list-style-type: none"> <li>No contact possible with another station.</li> </ul>	<ul style="list-style-type: none"> <li>The transceiver is set to semi-duplex.</li> <li>The other station is using code or tone squelch.</li> </ul>	<ul style="list-style-type: none"> <li>Set to simplex.</li> <li>Turn ON the code squelch or optional tone squelch (UT-85 is necessary.).</li> </ul>	<p>p. 18</p> <p>pgs. 38, 39</p>
<ul style="list-style-type: none"> <li>Repeater cannot be accessed.</li> </ul>	<ul style="list-style-type: none"> <li>Wrong offset frequency is programmed.</li> <li>Wrong subaudible tone frequency is programmed.</li> </ul>	<ul style="list-style-type: none"> <li>Correct the offset frequency in set mode.</li> <li>Correct the subaudible tone frequency in set mode.</li> </ul>	<p>p. 19</p> <p>p. 19</p>
<ul style="list-style-type: none"> <li>Frequency cannot be set.</li> </ul>	<ul style="list-style-type: none"> <li>The frequency lock function is activated.</li> <li>Priority watch is paused on the watching frequency.</li> </ul>	<ul style="list-style-type: none"> <li>Push [SET•LOCK] to turn the function OFF.</li> <li>Push [M/CALL•PRIO] to resume the watch.</li> </ul>	<p>p. 14</p> <p>p. 34</p>
<ul style="list-style-type: none"> <li>Some memory channels cannot be selected.</li> </ul>	<ul style="list-style-type: none"> <li>The memory channel is outside of the memory area.</li> </ul>	<ul style="list-style-type: none"> <li>Reset the memory area in set mode.</li> </ul>	<p>p. 23</p>
<ul style="list-style-type: none"> <li>Transmission is automatically cut off.</li> </ul>	<ul style="list-style-type: none"> <li>Time-out timer is activated.</li> </ul>	<ul style="list-style-type: none"> <li>Set the timer to OFF in initial set mode.</li> </ul>	<p>p. 48</p>

PROBLEM	POSSIBLE CAUSE	SOLUTION	REF.
<ul style="list-style-type: none"> <li>• Scan does not operate.</li> </ul>	<ul style="list-style-type: none"> <li>• Squelch is open.</li> <li>• The selected scan edge memory channels (e.g. 1A and 1b) have the same frequencies (for programmed scan).</li> <li>• All memory channels are programmed as skip channels (for memory scan).</li> <li>• Priority watch is activated.</li> </ul>	<ul style="list-style-type: none"> <li>• Set the squelch to the threshold point.</li> <li>• Re-program the scan edges.</li> <li>• Cancel the memory skip function for the desired channels.</li> <li>• Push [M/CALL•PRIO] to turn the function OFF.</li> </ul>	<p>p. 15 p. 29</p> <p>p. 31 p. 34</p>
<ul style="list-style-type: none"> <li>• All programmed memories have been erased.</li> </ul>	<ul style="list-style-type: none"> <li>• The CPU is malfunctioning.</li> <li>• Backup battery is exhausted.</li> </ul>	<ul style="list-style-type: none"> <li>• Reset the CPU.</li> <li>• Send the transceiver to an authorized Icom Dealer or Service Center to replace the backup battery.</li> </ul>	<p>p. 53 See below.</p>

## ■ Fuse replacement

If the fuse blows or the transceiver stops functioning, find the source of the problem if possible, and replace the damaged fuse with a new, rated fuse (20 A) as shown in the diagram below.

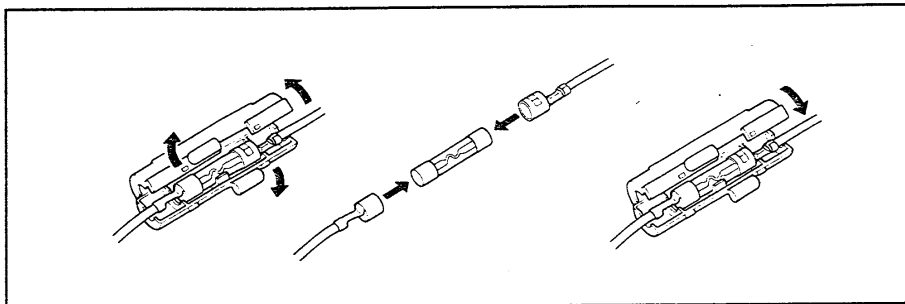

## ■ Backup batteries

**CAUTION:** The backup batteries must be replaced by an authorized Icom Dealer or Service Center. If a lithium backup battery is incorrectly replaced, an explosion may occur. Replace with the BR2032-1F2 (for the transceiver), BR2032-1T2 (for the HM-77/A) or equivalent types.

The transceiver and HM-77/A are equipped with separate lithium backup batteries for retaining memory information. When the battery is exhausted, the transceiver or HM-77/A operates normally but the CPU cannot retain memory information.

## ■ Partial resetting

If you want to initialize the operating conditions (VFO frequency, VFO settings, set mode settings, etc.) without clearing the memory contents or initial set mode settings, a partial reset function is available for the transceiver.

- ① Push [VOL] to turn power OFF.
- ② While pushing [SPCH], turn power ON to partially reset the transceiver.
  - All programmed contents, except for memory contents (call and scratch pad memories included) and initial set mode settings are cleared, and the transceiver displays its initial VFO frequency display.

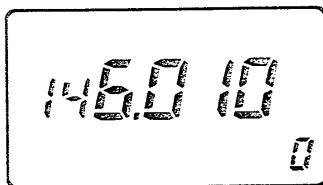

The display shows an initial VFO frequency display after partial resetting.

The frequency depends on versions.

## ■ Resetting the transceiver

The function display may occasionally display erroneous information, (e.g., when first applying power). This may be caused externally by static electricity or other factors.

If this problem occurs, turn power OFF. After waiting a few seconds, turn power ON again. If the problem persists, perform the following procedure.

Partial resetting is alternatively available. See left for details.

**NOTE:** Resetting the CPU **CLEARs** all memory information, and initializes all values in the transceiver.

- ① Push [VOL] to turn power OFF.
- ② While pushing [SET] and [SPCH], turn power ON.
  - All LCD segments appear momentarily, the initial display appears and the transceiver's CPU is reset.



# SPECIFICATIONS 19

## ■ GENERAL

- Frequency coverage

VERSION	MAIN BAND	RECEIVE BAND
U.S.A.	144–148 MHz	440–450 MHz
Asia	Tx : 144–148 MHz Rx : 136–174 MHz* <sup>1</sup>	430–440 MHz
Korea	144–146 MHz	435.075–440 MHz
Australia	144–148 MHz	430–440 MHz
Europe	144–146 MHz	430–440 MHz
Italy	Tx : 144–148 MHz Rx : 136–174 MHz* <sup>1</sup>	400–479 MHz* <sup>2</sup>

\*<sup>1</sup> Guaranteed frequency coverage is 144–148 MHz.

\*<sup>2</sup> Guaranteed frequency coverage is 430–440 MHz.

- Mode : FM
- Antenna impedance : 50 Ω (nominal)
- Power supply requirement : 13.8 V DC ± 15%
- Usable temperature range : -10 °C to +60 °C; +14 °F to +140 °F
- Dimensions : 140(W) × 40(H) × 171(D) mm  
(projections not included) 5.5(W) × 1.6(H) × 6.7(D) in
- Weight : 930 g; 2.1 lb

## ■ TRANSMITTER

- Modulation system : Variable reactance frequency modulation
- Max. frequency deviation : ± 5.0 kHz
- Spurious emissions : Less than -60 dB
- Microphone impedance : 600 Ω

- Output power and current drain:

CONDITION	IC-281H		IC-281A/E	
	POWER	CURRENT	POWER	CURRENT
HIGH	50 W	10.5 A	25 W	6.0 A
LOW 2	10 W	5.5 A	10 W	4.2 A
LOW 1	5 W	4.0 A	2 W	3.0 A

## ■ RECEIVER

- Receive system : Double-conversion superheterodyne
- Intermediate frequencies : 1st 30.85 MHz  
2nd 455 kHz
- Sensitivity (for 12 dB SINAD):  
144 MHz band : Less than 0.16 μV  
430(440) MHz band : Less than 0.2 μV
- Squelch sensitivity : Less than 0.13 μV (at threshold)
- Selectivity : More than 15 kHz/ -6 dB  
Less than 30 kHz/ -60 dB
- Spurious response rejection ratio : More than 60 dB
- Audio output power : More than 2.4 W at 10% distortion with the 8 Ω internal speaker.
- Current drain :  
Rated audio output : 1.0 A  
Squelched : 0.8 A

All stated specifications are subject to change without notice or obligation.

# 20 OPTIONS

## Unpacking

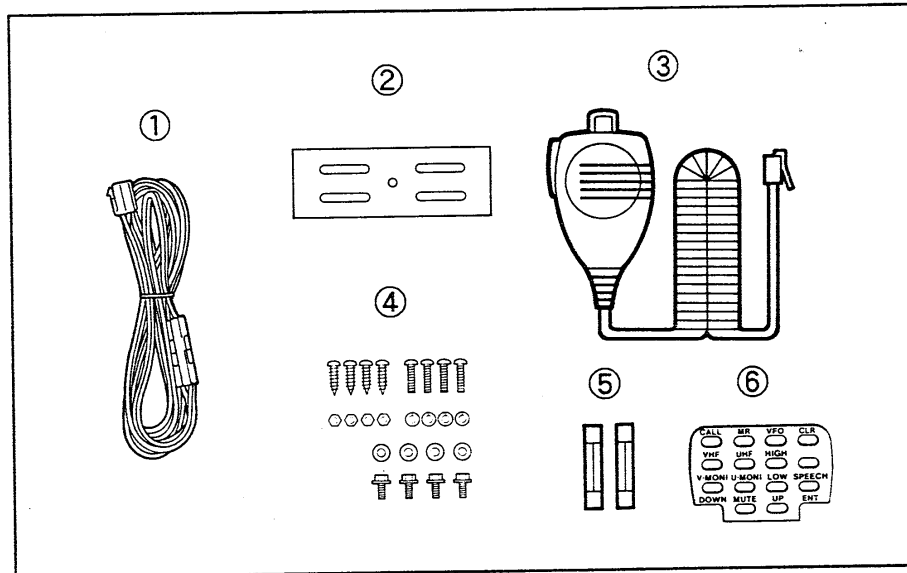

Accessories included with the transceiver:	Qty.
① DC power cable (OPC-346) .....	1
② Mounting bracket (MB-27) .....	1
③ Microphone* .....	1
④ Mounting screws, nuts and washers .....	1 set
⑤ Fuses (20 A) .....	2
⑥ Microphone sheet for HM-77/A .....	1

\* U.S.A./Korea versions : HM-77/A  
 Europe/Italy versions : HM-79  
 Other versions : HM-78

## Options

Some versions cannot use all of the following options since electrical standards, etc. vary between countries. Ask your Icom Dealer which options are available.

### SP-7 EXTERNAL SPEAKER

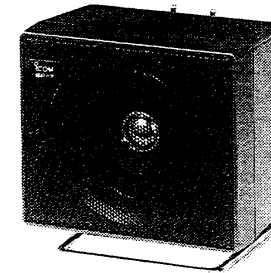

Cable length: 1.0 m; 3.3 ft

### SP-10 EXTERNAL SPEAKER

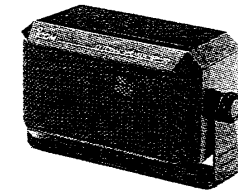

Cable length: 1.5 m; 4.9 ft

### SP-12 EXTERNAL SPEAKER

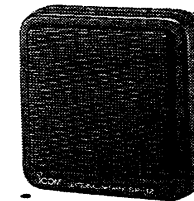

Cable length: 2.0 m; 6.6 ft

### MB-17A MOBILE MOUNTING BRACKET

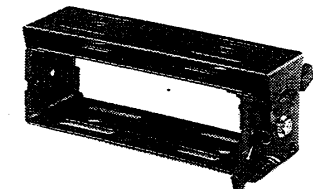

One-touch bracket. Transceiver body is easily attached and removed.

**AH-32 144/430(440) MHz DUAL BAND ANTENNA**

Dual band mobile antenna.

Frequency range : 144–148 MHz and 430–450 MHz

Max. input power : 150 W

**AHB-32 TRUNK MOUNT**

Trunk mount with a coaxial cable for the AH-32.

**HM-77/A DTMF MICROPHONE**

Same as supplied with the U.S.A. and Korea versions. Has a DTMF function and 14 DTMF memory channels. Required for Mic DTMF remote control. Also has a 1750 Hz tone call function.

**HM-78 HAND MICROPHONE**

Same as supplied with the Asia and Australia versions.

**HM-79 HAND MICROPHONE**

Same as supplied with the Europe and Italy versions. Has a 1750 Hz tone call function.

**MB-27 MOBILE MOUNTING BRACKET**

Same as the supplied one.

**MB-34 JOINT PLATES**

Used for stacking with Icom UHF mobile transceivers.

**OPC-346 DC POWER CABLE**

Same as supplied with the IC-281H. (20 A, 3 m; 9.8 ft)

**OPC-347 DC POWER CABLE**

Has 20 A capacity and a length of 7.0 m (23.0 ft).

**OPC-440 MIC EXTENSION CABLE**

Extends the microphone cable. Cable length is 5.0 m (16.4 ft).

**IC-PS30 DC POWER SUPPLY**

Provides 13.8 V DC and 25 A max. for base station use.

**UT-66 VOICE SYNTHESIZER UNIT**

Announces the displayed frequency.

**UT-85 TONE SQUELCH UNIT**

Provides pocket beep, tone squelch and tone scan functions. Also functions as a subaudible tone encoder.

